

ACTA-BACK® DEEP ORDER FORM

PRICING IN CANADIAN DOLLARS



Shown with Compass® 4 Quick Release 2 Point Hardware.
Cover appearance may vary with hardware selection.

Company Name/ACCT #: _____

P.O. Number: _____

Requested By: _____

Phone: _____ Fax: _____

Email: _____

Ship To: _____

Client Reference: _____

For best results, do not fill out in your browser. Interactive form should be completed using Adobe Reader after saving to your local drive. Then email or print and fax to Customer Support at sales.ca@permobil.com or 1.877.636.8944.

1 SIZE SELECTION

Required

BASE MSRP \$853.00

Sizes available are subject to hardware being used.

3" DEEP WING PART NUMBER

ABD3-BS _____

5" DEEP WING PART NUMBER

ABD5-BS _____

7" DEEP WING PART NUMBER

ABD7-BS _____

12W14L	14W14L
12W12L	14W12L

Sizes not available with 7" Deep Wings.

Please fill in one of the above with dimensions from the size charts to the right.

Example Part: **ABD5-BS14W16L**

Hardware will be selected in Section 2.

IF DESIRED SIZE IS NOT LISTED, PLEASE CONTACT CUSTOMER SERVICE FOR ASSISTANCE. | 800.265.9830

*Length (L) refers to the actual size dimension of the support from bottom to top edge.

Sizes available with 2 POINT Mounting Hardware

LENGTH*	22"		16W22L	18W22L	20W22L	22W22L	
	20"		14W20L	16W20L	18W20L	20W20L	22W20L
	18"	12W18L	14W18L	16W18L	18W18L	20W18L	22W18L
	16"	12W16L	14W16L	16W16L	18W16L	20W16L	22W16L
	14"	12W14L	14W14L	16W14L	18W14L	20W14L	
	12"	12W12L	14W12L	16W12L	18W12L		
		12"	14"	16"	18"	20"	22"
FRAME WIDTH							

Sizes available with 4 POINT Mounting Hardware

LENGTH*	22"		16W22L	18W22L	20W22L	22W22L	24W22L
	20"		14W20L	16W20L	18W20L	20W20L	22W20L
	18"	12W18L	14W18L	16W18L	18W18L	20W18L	22W18L
	16"	12W16L	14W16L	16W16L	18W16L	20W16L	22W16L
	14"	12W14L	14W14L	16W14L	18W14L	20W14L	
	12"						
		12"	14"	16"	18"	20"	22"
FRAME WIDTH							

Sizes available with POWER Mounting Hardware

LENGTH*	22"		16W22L	18W22L	20W22L	22W22L	24W22L
	20"		14W20L	16W20L	18W20L	20W20L	22W20L
	18"		14W18L	16W18L	18W18L	20W18L	22W18L
	16"		14W16L	16W16L	18W16L	20W16L	22W16L
	14"	12W14L	14W14L	16W14L	18W14L	20W14L	
	12"	12W12L	14W12L	16W12L	18W12L		
		12"	14"	16"	18"	20"	22"
FRAME WIDTH							

2 COVER & ADD-ON SELECTION

Cover required

2.1 COVER SELECTION

MSRP \$0.00

Both fabrics are latex-free. Fabric selection is for the support surface only. Other fabrics used in cover construction remain the same.

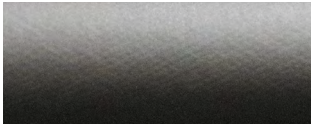

COMFORT-TEK® is a smooth, easily cleaned surface. The fluid protection aids in infection control.

COMFORT-TEK® Cover
(COMFORT-TEK)



STRETCH-AIR® has comfortable stretch, air transmission and heat dissipation. It is not fluid resistant.

STRETCH-AIR® Cover
(STRETCH-AIR)

2.2 PRIVACY FLAP

MSRP \$76.00

This flap connects with hook & loop attachment between the seat and back for added privacy.

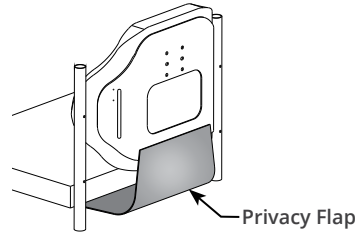

PRIVACY FLAP (PV-FLAP)

3 HARDWARE STYLE

COMPASS® 4 QUICK RELEASE

Price included in back support purchase

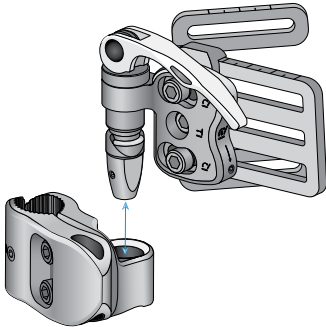

QUICK RELEASE 2 POINT
(Q-COMPASS)

QUICK RELEASE 4 POINT
(Q-COMPASS4)

4 POINT hardware is required on all 24"W back supports using Compass® 4 hardware.

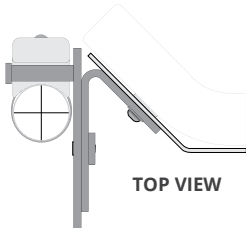

COMPASS® 4 FIXED

Price included in back support purchase

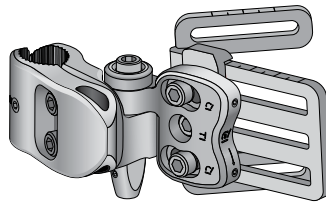

FIXED fully adjustable hardware requires tools for back support removal

FIXED 2 POINT
(NQ-COMPASS)

FIXED 4 POINT
(NQ-COMPASS4)

COMPASS® POWER MOUNT

MSRP add \$82.00

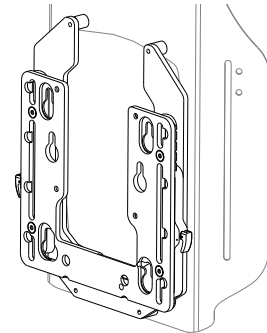

POWER MOUNT hardware has 8" of height adjustment in 1/2" increments without using tools.

QUANTUM w/ TRU BALANCE 3
(PMB-QUANTUM)

PERMOBIL w/ CORPUS 3G
(PMB-PERMOBIL)

QUICKIE w/ 3.7 POWER
(PMB-QUICKIE)

AVID REHAB w/ POWER T & R
(PMB-AVID)

ROVI w/ MOTION CONCEPTS*
(PMB-ROVI)

*Using Power Mount Hardware on ROVI requires mounting to the RECESSED PLANAR INTERFACE PLATE available when ordering the Motion Concepts Seating System. Drilling is required for mounting.

4 BODILINK HEAD SUPPORT HARDWARE & PADS

4.1 PREMIUM PAD SIZE

MSRP \$247.00

Length (L) refers to the actual size dimension of the support from bottom to top edge.

W		Pad Firmness	
L	6W x 3L	Soft	BL-HSP1-6W3L
		Extra Soft	BL-HSP2-6W3L
L	8W x 4L	Soft	BL-HSP1-8W4L
		Extra Soft	BL-HSP2-8W4L
L	10W x 5L <i>with adjustable wings</i>	Soft	BL-HSP1-10W5L
		Extra Soft	BL-HSP2-10W5L
L	12W x 5L <i>with adjustable wings</i>	Soft	BL-HSP1-12W5L
		Extra Soft	BL-HSP2-12W5L
L	14W x 5L <i>with adjustable wings</i>	Soft	BL-HSP1-14W5L
		Extra Soft	BL-HSP2-14W5L
L	18W x 5L <i>with adjustable wings</i>	Soft	BL-HSP1-18W5L
		Extra Soft	BL-HSP2-18W5L



Premium head support pad angles can be formed by adjusting the plates in the pad.

4.2 PREMIUM PAD COVER MATERIAL

	FOR SKIN PROTECTION & SHEAR REDUCTION. NOT FLUID RESISTANT.
	FOR FLUID PROTECTION & AN EASILY CLEANED SURFACE.
	FOR PATIENT COMFORT.

	GlideWear™ (GLIDEWEAR) (add \$82.00)
	COMFORT-TEK (COMFORT-TEK)
	STRETCH-AIR (STRETCH-AIR)

4.3 BASIC PAD SIZE

MSRP \$247.00

Length (L) refers to the actual size dimension of the support from bottom to top edge.

W		
L	6W x 5L	BL-HSP3-6W5L
L	8W x 5L	BL-HSP3-8W5L
L	10W x 6L	BL-HSP3-10W6L
L	12W x 6L	BL-HSP3-12W6L
L	14W x 6L	BL-HSP3-14W6L
L	18W x 6L	BL-HSP3-18W6L



Basic head support pads can be formed to any shape using the moldable steel insert inside the pad.

4.4 BASIC PAD COVER MATERIAL

	FOR FLUID PROTECTION & AN EASILY CLEANED SURFACE.
	FOR PATIENT COMFORT & HEAT DISSIPATION.

	COMFORT-TEK (COMFORT-TEK)
	STRETCH-AIR (STRETCH-AIR)

4.5 PT HARDWARE

- Make one selection per column in subsection A, B, or C.
- If A is chosen, choose a stem length option.
- Choose mounting block option in 4.6.

RANGE OF MOTION

PT MODEL	TOTAL # OF LINKS	TOTAL LINK LENGTH	MAX ANTERIOR REACH	MAX POSTERIOR REACH	MAX LATERAL REACH
MID 6	2	6"	5.5"	1"	N/A
LAT 6	3	6"	5.5"	1"	6"
MID 8	2	8"	7.5"	1"	N/A
LAT 8	3	8"	7.5"	1"	8"
MAX 8	4	8"	7.5"	3"	8"

A. PT HARDWARE, REMOVABLE

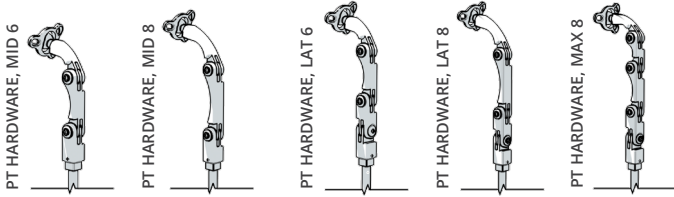

SHAPE	MSRP	PART NUMBER
MID 6	\$355.00	(BL-HS-PT1RMMID6)
LAT 6	\$465.00	(BL-HS-PT1RMLAT6)
MID 8	\$355.00	(BL-HS-PT1RMMID8)
LAT 8	\$465.00	(BL-HS-PT1RMLAT8)
MAX 8*	\$519.00	(BL-HS-PT1RMMAX8)

*Provides the greatest amount of articulation and range of motion.

PT HARDWARE, REMOVABLE, STEM LENGTH OPTION

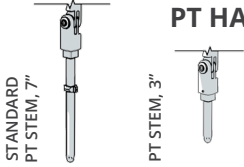

STEM LENGTH	MSRP	PART NUMBER
STANDARD 7" STEM	\$0.00	(HS-STEM-7)
**3" STEM	\$0.00	(HS-STEM-3)

**3" Stem is recommended for use with power mounting where there may be special constraints with power chair functions.

B. PT HARDWARE, FLIP-DOWN

Flip-Down Hardware has 7" Stem

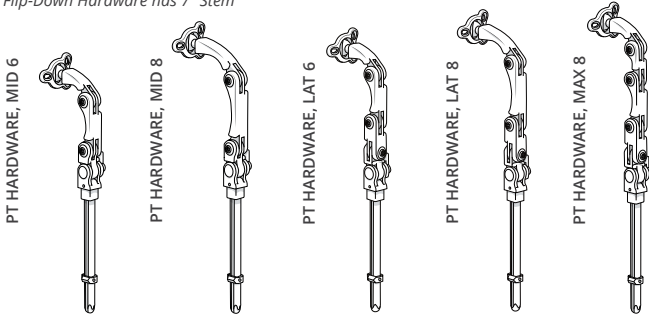

SHAPE	MSRP	PART NUMBER
MID 6	\$399.00	(BL-HS-PT1FDMID6)
LAT 6	\$504.00	(BL-HS-PT1FDLAT6)
MID 8	\$399.00	(BL-HS-PT1FDMID8)
LAT 8	\$504.00	(BL-HS-PT1FDLAT8)
MAX 8*	\$562.00	(BL-HS-PT1FDMAX8)

*Provides the greatest amount of articulation and range of motion.

C. GT HARDWARE, REMOVABLE



GT HARDWARE RANGE OF MOTION

GT MODEL	TOTAL # OF LINKS	TOTAL LINK LENGTH	MAX. ANTERIOR REACH	MAX. POSTERIOR REACH	MAX. LATERAL REACH
LAT	5	10.5"	10"	2"	7.5"
MID	3	8.5"	8"	2"	N/A

STYLE	MSRP	PART NUMBER
LATERAL	\$333.00	(BL-HS-GT3RMLAT)
MID-LINE	\$296.00	(BL-HS-GT3RMMID)

4.6

HEAD SUPPORT MOUNTING OPTION

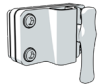

MOUNTING BLOCK-POSTERIOR A

MOUNTING BLOCK OR BRACKET	MSRP	PART NUMBER
POSTERIOR A MOUNTING BLOCK	\$0.00	(HS-MB-POSTA)

4.7

EXTRA HARDWARE

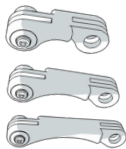

LINK LENGTH	MSRP	EXTRA PART
*EXTRA 2" LINK	\$108.00	(BL-HS-PT1LINK2)
*EXTRA 3" LINK	\$108.00	(BL-HS-PT1LINK3)
*EXTRA 4" LINK	\$108.00	(BL-HS-PT1LINK4)

*FOR PT HARDWARE ONLY



TOOL-LESS WING LOCK	MSRP	EXTRA PART	EXTRA PART	EXTRA PART	EXTRA PART
*1 LOCK	\$44.00/each	(BL-HS-52WINGA1)	(BL-HS-52WINGA1)	(BL-HS-52WINGA1)	(BL-HS-52WINGA1)



ADDITIONAL	MSRP	EXTRA PART
1/4" SPACER PLATE	\$82.00/each	(BL-HS-SPCRA)

The following are registered trademarks of Permobil Seating and Positioning: ACTA-BACK®, BodiLink®, COMFORT-TEK®, Compass®, and STRETCH-AIR®. GlideWear® is a trademark of Tamarack Habilitation Technologies, Inc.