

Date	UK (English)	
User	Company stamp	Rigid frame wheelchair
End user weight (kg)		£ no list
Language user manual	Responsible	Retail price - VAT not included

Wheelchair measures - The tolerance on all the dimensions indicated and/or required is ± 10 mm

Seat width (LS) 33 36 39 42 45 48
 The seat width is measured from the outer sides of the frame, while the distance between the two side guards is 1.5 cm wider.
For seat enlargement see section enlargement of mudguard

Seat depth (PS) 35 37,5 40 42,5 45 47,5 50
 The real seat depth, from the front part of the seat cloth to the backrest tube will be 1,5 cm more than the declared one.

Footplate distance (DP) (cm) ±0.5cm - adjustment steps 1.5cm
(Real distance between seat and footplate) - IMPORTANT NOTICE! From the footplate to the floor minimum 4cm !! (Minimum Front height = DP + 4cm)

Setting ☆ Standard Prudential Active Extreme

Backrest Height (TS) Std.Value 33,5(min 26-max 47) adjustment steps 1.5cm

Camber ☆ 0° 2° 4°

Frame's depth

Front frame extension + 2,5 cm
 Only available with black colour frame



12842

☆ Standard rear adjustment

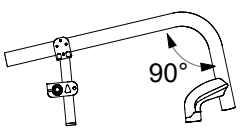

☆ Carbon fibre mudguard
 Carbon fibre Straight sideguard

Removable version
The distance between the two side guards is 1 cm wider than the seat width

Mudguard enlargement

☆ + 0 cm
 + 1 cm

12648



13597 **135,00**



FULL CARBON rear adjustment plate with integrated sideguard
Lightest configuration

07646 **1.006,00**

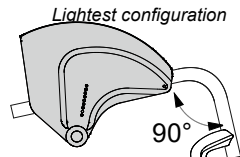
☆ Version mudguard (Available only with rear wheels 24")



Front height - Tick the box with the required height
 The possible difference in height between HIGH frame and LOW frame is 3cm (with same fork, caster and assembly hole).

	 <i>SPORT fork (H95)</i>	 <i>Small size fork (H115)</i>
LOW FRAME 90° Front height (min 44,5 - max 50) Footplate distance (min 33) <div style="border: 1px solid black; padding: 2px; margin-top: 5px;"> <i>U-TUBE Aluminium footplate</i> Footplate distance (min 18 + max 35) DPmax = Front height - 10cm </div>	<i>Casters</i> 3" <input type="checkbox"/> ~45 <input type="checkbox"/> ~46 4" <input type="checkbox"/> ~46 <input type="checkbox"/> ~47 5" <input type="checkbox"/> ~48,5	<i>Casters</i> 3" <input type="checkbox"/> ~45,5 <input type="checkbox"/> ~47 4" <input type="checkbox"/> ~46,5 <input type="checkbox"/> ~48 <input type="checkbox"/> ~49 5" <input type="checkbox"/> ~49 <input type="checkbox"/> ~50
HIGH FRAME 90° Front height (min 47,5 - max 53) Footplate distance (min 36) <div style="border: 1px solid black; padding: 2px; margin-top: 5px;"> <i>U-TUBE Aluminium footplate</i> Footplate distance (min 21 + max 38) DPmax = Front height - 10cm </div>	<i>Casters</i> 3" <input type="checkbox"/> ~48 <input type="checkbox"/> ~49 4" <input type="checkbox"/> ~49 <input type="checkbox"/> ~50 5" <input type="checkbox"/> ~51,5	<i>Casters</i> 3" <input type="checkbox"/> ~48,5 <input type="checkbox"/> ~50 4" <input type="checkbox"/> ~49,5 <input type="checkbox"/> ~51 <input type="checkbox"/> ~52 5" <input type="checkbox"/> ~52 <input type="checkbox"/> ~53

The real front-seat height could be slightly different from the chosen one considering it is affected by seat depth and rear seat height.

Rear height **The difference between Front Height and Rear Height must be in the 3 - 12 cm range.**

Rear wheels 22" (min 36 - max 44)
 Rear wheels 24" (min 38 - max 46)
 Rear wheels 25" (min 39 - max 47)
 Rear wheels 26" (min 41 - max 48)

Date Order User Address

Seat

☆ Seat cloth with pocket (under seat)

Seat with tension straps 08883 **240,00**

Carbon rigid seat 08336 **509,00**

Pocket (under seat) [25x11x4,5] 08281 **79,00**

CUSTOMIZE COLORS

① Frame colour
(without extra charge)

☆ Opaque black

POLAR white

Matt orange

Tekno anthracite

Matt Midnight blue

Matt grey

Matt red

Frame colour on request

Bright silver

Bright red

Bright blue

Bright fuchsia

Bright lime

12579 **109,00**

② Fork colour

☆ Opaque black

Bright silver

POLAR white

Bright red

Tekno anthracite

Matt grey

Bright blue

Bright fuchsia

Bright lime

Matt Midnight blue

Matt red

08342 **68,00**

③ Colour rear wheels
To be matched only with: Rear wheels Ultra-light Progeo - Standard! (22 - 24)

☆ Black

Bright silver

POLAR white

Bright red

Tekno anthracite

Matt grey

Bright blue

Bright fuchsia

Bright lime

Matt Midnight blue

Matt red

04692 **68,00**

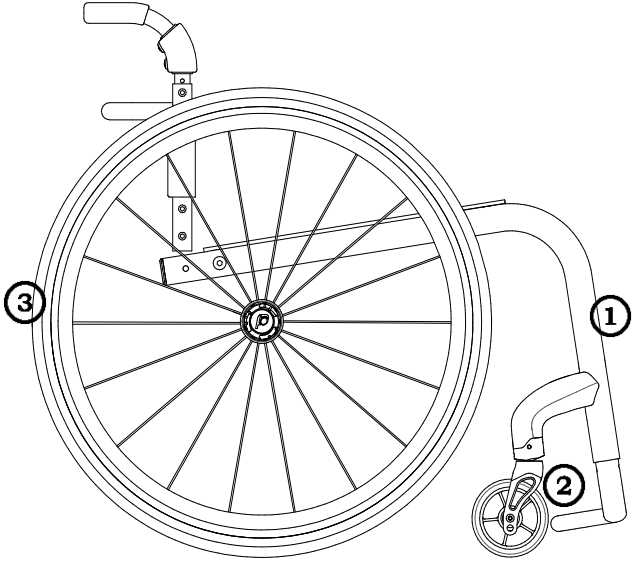

Rear wheels axle

☆ Aluminum rear wheels axle

Carbon fiber rear wheels axle *Lightest configuration* 07647 **158,00**

Backrest adjustment and fixing system

☆ Backrest with double locking (upright and folded) **with rake adjustable from -4° to +16°**

Backrest with upright locking system ONLY (no locking when folded) **with rake adjustable from -4° to +16°**

Fixed back(non-folding back) **with rake adjustable from -4° to +16°**

Backrest

☆ Adjustable velcro straps and padded transpiring upholstery

☆ Aluminium backrest



Titanium backrest 13599 **203,00**

Carbon fibre backrest 04389 **802,00**

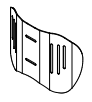

AIR Integrated posture backrest (NOT REMOVABLE) **1.121,00**

Carbon shell - Lateral retaining 7,5cm
Depth adjustment ±1cm. - Angle adjustment ±10°
not available for seat width 48

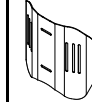
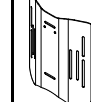
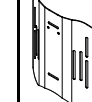
H 28		H 34		H 40	
Backrest Height (TS) min 34		Backrest Height (TS) min 38		Backrest Height (TS) min 44	
(.....)		(.....)		(.....)	
Lateral retaining wing A=high - R=regular					
A	R	A	R	A	R
					
<input type="checkbox"/>	<input type="checkbox"/>	<input type="checkbox"/>	<input type="checkbox"/>	<input type="checkbox"/>	<input type="checkbox"/>

Installation on:

☆ Backrest tubes

Aluminium backrest

Titanium backrest 13599 **203,00**

Carbon fibre backrest 04389 **802,00**



Date	Order	User	Address
------------	-------------	------------	---------------

Handle tube			
☆ Tubes with standard handle			
<input type="checkbox"/> Tubes with short handle			
<input type="checkbox"/> SPORT tubes Without push handles			
<input type="radio"/> Carbon fibre tubes with short handle	<i>Lightest configuration</i>	04390	158,00
Not available with: Posture backrest PHYSIO - Posture backrest A I R			
<input type="radio"/> Folding handles	Minimum backrest height 30,5cm	13598	270,00
Not available with: Push handles for companion			



Casters			
☆ 4" Soft			
<input type="checkbox"/> 3" Sport			
<input type="checkbox"/> 5" Soft			
<i>Lightest configuration</i>			
<input type="radio"/> 3" Active Soft (wide)	(Aluminium alloy rim)	13592	95,00
<input type="radio"/> 4" Active Sport (narrow)	(Aluminium alloy rim)	13593	95,00
<input type="radio"/> 4" Active Soft (wide)	(Aluminium alloy rim)	13594	95,00
<input type="radio"/> 5" Active Soft (wide)	(Aluminium alloy rim)	13595	95,00
<input type="radio"/> 5" Pneumatic		13596	68,00

Rear wheels			
☆ 24" Ultra-light Progeo - Standard!			
<input type="checkbox"/> 22" Ultra-light Progeo - Standard!			
<input type="checkbox"/> 25" Ultra-light Progeo - Standard! (colour: black)			
<input type="checkbox"/> 26" Progeo - Standard! (colour: black)			
<input type="radio"/> 24" ULTRA-LIGHT PROGEO KEY SPORT	<i>Lightest configuration</i>	13585	695,00
<input type="radio"/> 24" Ultra-light "Spinergy LX"		13586	695,00
<input type="radio"/> 24" Ultra-light "Spinergy LXL"	<input type="checkbox"/> Black hub and white spokes <input type="checkbox"/> Hub and spokes black	13587	695,00
<input type="radio"/> 24" Ultra-light "Spinergy Flex rim"	Integrated aluminium/rubber handrim	02270	1.150,00
<input type="radio"/> 25" Ultra-light "Spinergy LX"		13588	695,00
<input type="radio"/> 25" Ultra-light "Spinergy LXL"	<input type="checkbox"/> Black hub and white spokes	13589	695,00
<input type="radio"/> 26" Ultra-light "Spinergy LX"		13590	695,00
<input type="radio"/> 24" Off-road (aluminium handrim black - Wheel distance 4cm)		01392	270,00

Rear wheel tyre			
☆ High pressure tyre	(22"-24"-25"-26")	<i>Lightest configuration</i>	
<input type="checkbox"/> High pressure profile tyre	(24")		
<input type="radio"/> Marathon Plus	(24"-25")	with anti-puncture protection	01669 95,00
<input type="radio"/> Anti-puncture - Colour Grey	(22")		04181 105,00
<input type="radio"/> Anti-puncture - Colour Black	(24")		11083 95,00
Not available with Rear wheels : 24" ULTRA-LIGHT PROGEO KEY SPORT, 24" Ultra-light "Spinergy LXL"			

Handrim			
		Wheel distance ☆ 3 cm <input type="checkbox"/> 4 cm	
☆ Aluminium	(22"-24"-25"-26")	<i>Lightest configuration</i>	
<input type="radio"/> Aluminium black SOFT-TOUCH	(24"-25")	(24" handrim, on 25" wheel is installed with spacers)	09170 160,00
<input type="radio"/> Chromed Steel	(24"-25")	(24" handrim, on 25" wheel is installed with spacers)	01684 160,00
<input type="radio"/> Titanium	(24"-25")	(24" handrim, on 25" wheel is installed with spacers)	13591 290,00
<input type="radio"/> Ultra Grepp	(24"-25")	(24" handrim, on 25" wheel is installed with spacers)	00017 290,00
<input type="radio"/> TOP FRICTION	(24"-25")	(24" handrim, on 25" wheel is installed with spacers)	11023 290,00
Oval countour with a rubber insert			
<input type="radio"/> NOVA H	(24"-25")	(24" handrim, on 25" wheel is installed with spacers)	11025 290,00
Ergonomic black profile			
<input type="radio"/> NOVA D	(24"-25")	(24" handrim, on 25" wheel is installed with spacers)	11026 290,00
Ergonomic profile with rubber coating (ideal for quadriplegics)			
<input type="radio"/> Silicon cover for standard aluminium handrim		Available for measures (22"- 24" - 26")	04050 172,00

Wheel locks			
☆ Bent lever push to lock			
<input type="checkbox"/> Straight lever push to lock			
<input type="checkbox"/> Straight lever pull to lock			
<input type="radio"/> Sport brake		06428	135,00
<input type="radio"/> Brake with extension lever push to lock		01949	68,00
<input type="radio"/> Brake with extension lever pull to lock		03372	68,00

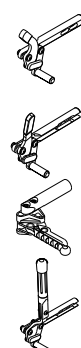

Date	Order	User	Address
------------	-------------	------------	---------------

Footplate

- ☆ Aluminium footplate. Rake not adjustable
 - ☆ Aluminium footplate with plastic plate

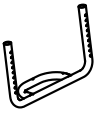
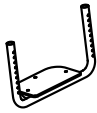

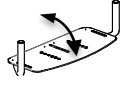
 - One piece aluminium footplate - Flip-up! FLIP-BACK! - rake and depth adjustable
 IMPORTANT NOTICE! From the footplate to the floor minimum 6cm !! (Minimum Front height = DP + 4cm)
 With 5" front wheel the difference between Front Height and Rear Height must be greater than 5cm
 - Aluminium footplate - rake and depth adjustable
 - ☆ Internal 2/3 Internal External 2/3 External

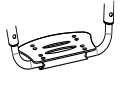

09420 **203,00**
 - U-TUBE - Aluminium footplate, rake and depth adjustable
 LOW FRAME: minimum footplate distance 18 - maximum footplate distance 35
 HIGH FRAME: minimum footplate distance 21 - maximum footplate distance 38



04456 **270,00**
 - One piece Carbon fibre footplate. Rake adjustable
 - ☆ Internal External



09853 **240,00**
 - One piece Carbon fibre footplate. Rake adjustable
 - ☆ Internal External

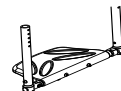

04110 **398,00**

Armrests

- Tubular armrests (Swing away, removable and height adjustable armrest)



00694 **270,00**
- Removable armrest with carbon-fiber straight sideguard
Available only with: Standard rear adjustment



09079 **240,00**

Accessories

- Pad for front frame protectors 07058 **56,00**
- Backrest-seat connection cloth 10241 **25,00**
- Removable storage bag (with quick coupling) 09811 **135,00**

Optional 1

Only one optional devices for side can be chosen

- Transit wheels Exclude the installation of Anti-tippers



03290 **158,00**
- Anti-tipper with rapid hookup Exclude the installation of Transit wheels
(inside rotation to reduce the encumbrance)
 - Right
 - Left



06821 **145,00**
06822 **145,00**

Optional 2

- Push handles for companion (Removable and height adjustable)



13600 **189,00**
- Tetraclip (Quick release axle for quadriplegic)



03947 **189,00**
- Safety pelvic belt 03972 **68,00**
- Harness 04103 **145,00**
- Lumbar support (to insert in the backrest upholstery) 00013 **43,00**
- Right swing away lateral support Not available with Posture backrest PHYSIO - Posture backrest A I R
 - Right
 - Left



02097 **270,00**
02098 **270,00**
- Spoke guards Black (22"-24") 01043 **158,00**
- Spoke guards Transparent (22"-24") 00835 **158,00**
- Spoke guards Progeo design (22"-24") 00019 **189,00**

Additional Kit

- 24" Off-road rear wheels Off-Road tyre - aluminium handrim (black colour) 03378 **534,00**
- 24" FAT rear wheels FAT tyre 3" - aluminium handrim (black colour) 09357 **895,00**

Date Order User Address

PHYSIO - Posture backrest (Std. Backrest upholstery not provided)

Removable with quick release
Suitable for tubes with diameter 18+26mm
Depth adjustment (4cm)
Angle adjustment ($\pm 18^\circ$)

- AIR** Carbon shell
not available for seat width 48

BACKREST HEIGHT	28	34	40			
Shell's shape  7.5 cm	Lateral retaining wing A=high - R=regular					
	A	R	A	R	A	R
	<input type="checkbox"/>	<input type="checkbox"/>	<input type="checkbox"/>	<input type="checkbox"/>	<input type="checkbox"/>	<input type="checkbox"/>

1.121,00

- POSTURE** Aluminum shell

BACKREST HEIGHT	34	40	52		
Shell's shape  7.5 cm	Lateral retaining wing R=regular				
	R	R	R		
	<input type="checkbox"/>	<input type="checkbox"/>	<input type="checkbox"/>		

1.085,00

Configuration DEEP with side support PAD (height adjustable)

Alluminum lateral with padded, breathable upholstery.



Small (h 13cm)



Right
10272

49,00

Left
10272

49,00

Large (h 20cm)



Right
10273

49,00

Left
10273

49,00

SWING AWAY - Lateral support

Fixing and adjustment hardware complete with protection sleeve
Alluminum lateral with padded, breathable upholstery.

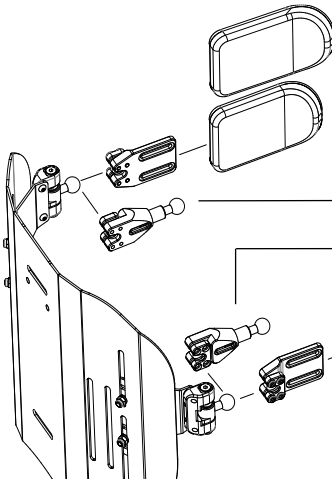

Large (18x12)

05647 196,00

Small (14x9)

05643 196,00

Lateral support extension

Quantity (number pcs).....

10271 74,00

Lateral support extension

Quantity (number pcs).....

Small (14x9)

05642 196,00

Large (18x12)

05646 196,00

- Headrest adjustable - Double ball mounting system

Available only with backrest Physio Posture



- Large (35x12,5)
- Small (25x12,5)

05648 385,00





Date	Order	User	Address
------------	-------------	------------	---------------

Note

Wheelchair : Progeo JOKER R2 - Rev. 2026.0	Prices - VAT excluded <small>to be added to the price list</small>	<table border="1" style="width: 100%; border-collapse: collapse;"> <tr> <td colspan="2" style="text-align: center; padding: 2px;">Send this page only if any optional have been chosen</td> </tr> <tr> <td style="width: 10px; text-align: center; padding: 2px;"><input checked="" type="checkbox"/></td> <td style="padding: 2px;"> standard (supplied if no requests are indicated) </td> </tr> <tr> <td style="text-align: center; padding: 2px;"><input type="checkbox"/></td> <td style="padding: 2px;"> on request (without extra charge) </td> </tr> <tr> <td style="text-align: center; padding: 2px;"><input type="checkbox"/></td> <td style="padding: 2px;"> optional (cost to be added at the basic price) </td> </tr> </table>	Send this page only if any optional have been chosen		<input checked="" type="checkbox"/>	standard (supplied if no requests are indicated)	<input type="checkbox"/>	on request (without extra charge)	<input type="checkbox"/>	optional (cost to be added at the basic price)
Send this page only if any optional have been chosen										
<input checked="" type="checkbox"/>	standard (supplied if no requests are indicated)									
<input type="checkbox"/>	on request (without extra charge)									
<input type="checkbox"/>	optional (cost to be added at the basic price)									

Date Order User Address

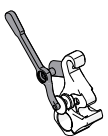
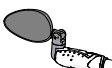
Accessories

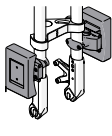
- | | | | | |
|---|---|---|--------|--------|
| <input type="radio"/> FULL LED light (high intensity)
Integrated in the spoiler |  | 10908 | 107,00 | |
| <input type="radio"/> Handlebar extension
Adjustable from 15cm up to 23cm |  | 10907 | 182,00 | |
| <input type="radio"/> Motor unit facilitated unlock lever
Recommended with handlebar for quadriplegic |  | 10915 | 82,00 | |
| <input type="radio"/> Additional FLY 48V - 2.9 Ah battery
Autonomy up to 15km
Approved for air transport | | 10906 | 697,00 | |
| <input type="radio"/> Rearview mirror | <input type="radio"/> Right
<input type="radio"/> Left |  | 10909 | 32,00 |
| | | | 10909 | 32,00 |
| <input type="radio"/> Basket (removable) - (with KLICKfix® attachment system) | |  | 10912 | 212,00 |
| <input type="radio"/> Removable front weight - (with KLICKfix® attachment system)
(it increases the weight over the power wheel to improve traction) | |  | 10910 | 311,00 |
| <input type="radio"/> Travel bag | | | 10916 | 155,00 |

Note

Send this page only if any optional have been chosen

- | | | |
|-------------------------------------|------------|---|
| <input checked="" type="checkbox"/> | standard | (supplied if no requests are indicated) |
| <input type="checkbox"/> | on request | (without extra charge) |
| <input type="radio"/> | optional | (cost to be added at the basic price) |

Wheelchair : Progeo JOKER R2 - Rev. 2026.0

Prices - VAT excluded
to be added to the price list