

EMBRACE® ATI ORDER FORM



PRICING IN CANADIAN DOLLARS

Company Name/ACCT #: _____

P.O. Number: _____

Requested By: _____

Phone: _____ Fax: _____

Email: _____

Ship To: _____

Client Reference: _____

For best results, do not fill out in your browser. Interactive form should be completed using Adobe Reader [after](#) saving to your local drive. Then email or print and fax to Customer Support at sales.ca@permobil.com or 1.877.636.8944.

Embrace ATI Zero Elevation
shown with GlideWear™

Embrace ATI Anti-Thrust



ATI - Adjustable Technology Insert

1 SIZE, STYLE & COVER

STYLES

ZERO ELEVATION ANTI-THRUST

DEPTH											21"				22"				23"				24"									
	10"	11"	12"	13"	14"	15"	16"	17"	18"	19"	20"	21"	22"	23"	24"	21"	22"	23"	24"	21"	22"	23"	24"	21"	22"	23"	24"					
24"											18 x 24	19 x 24	20 x 24	21 x 24	22 x 24	23 x 24	24 x 24															
23"											18 x 23	19 x 23	20 x 23	21 x 23	22 x 23	23 x 23	24 x 23															
22"											16 x 22	17 x 22	18 x 22	19 x 22	20 x 22	21 x 22	22 x 22	23 x 22	24 x 22													
21"											15 x 21	16 x 21	17 x 21	18 x 21	19 x 21	20 x 21	21 x 21	22 x 21	23 x 21	24 x 21												
20"											14 x 20	15 x 20	16 x 20	17 x 20	18 x 20	19 x 20	20 x 20	21 x 20	22 x 20	23 x 20	24 x 20											
19"											14 x 19	15 x 19	16 x 19	17 x 19	18 x 19	19 x 19	20 x 19	21 x 19	22 x 19	23 x 19	24 x 19											
18"											12 x 18	13 x 18	14 x 18	15 x 18	16 x 18	17 x 18	18 x 18	19 x 18	20 x 18	21 x 18	22 x 18	23 x 18	24 x 18									
17"											11 x 17	12 x 17	13 x 17	14 x 17	15 x 17	16 x 17	17 x 17	18 x 17	19 x 17	20 x 17	21 x 17	22 x 17	23 x 17	24 x 17								
16"	10 x 16	11 x 16	12 x 16	13 x 16	14 x 16	15 x 16	16 x 16	17 x 16	18 x 16	19 x 16	20 x 16	21 x 16	22 x 16	23 x 16	24 x 16																	
15"	10 x 15	11 x 15	12 x 15	13 x 15	14 x 15	15 x 15	16 x 15	17 x 15	18 x 15	19 x 15	20 x 15																					
14"	10 x 14	11 x 14	12 x 14	13 x 14	14 x 14	15 x 14	16 x 14	17 x 14	18 x 14	19 x 14																						
13"	10 x 13	11 x 13	12 x 13	13 x 13	14 x 13	15 x 13	16 x 13	17 x 13																								
12"	10 x 12	11 x 12	12 x 12	13 x 12	14 x 12	15 x 12	16 x 12	17 x 12																								
11"	10 x 11	11 x 11	12 x 11	13 x 11	14 x 11	15 x 11																										
10"	10 x 10	11 x 10	12 x 10	13 x 10	14 x 10	15 x 10																										

PRICING		
CUSHION SIZE	COMFORT-TEK OR STRETCH-AIR	WITH GLIDEWEAR
Standard	\$709.00	\$735.00
Bariatric >20"	\$893.00	\$919.00

COVER & LINER OPTIONS	
	COMFORT-TEK® For fluid protection & an easily cleaned surface.
	STRETCH-AIR® For patient comfort & heat dissipation.

ACCESSORIES	
EXTRA COMFORT-TEK OUTER COVER	
Regular:	One = \$125.00
(EM- <i>WWDD-CV</i>)	Two = \$250.00
with GlideWear:	One = \$150.00
(+CC-GLIDEWEAR)	Two = \$300.00

ACTA-EMBRACE ATI PART NUMBERS		
CUSHION STYLE	STRETCH-AIR	COMFORT-TEK
Zero Elevation	EM-SZM- <i>WWDD</i>	EM-FZM- <i>WWDD</i>
Anti-Thrust	EM-SAM- <i>WWDD</i>	EM-FAM- <i>WWDD</i>
	STRETCH-AIR + GLIDEWEAR	COMFORT-TEK + GLIDEWEAR
Zero Elevation	EM-SQZM- <i>WWDD</i>	EM-FQZM- <i>WWDD</i>
Anti-Thrust	EM-SQAM- <i>WWDD</i>	EM-FQAM- <i>WWDD</i>

	GLIDEWEAR™ Promotes healing & reduces risk of skin breakdown* <small>*A GlideWear® Shear Reduction Panel is incorporated into the cover under the most at-risk areas to allow for micro-movements without the deformation of tissue. U.S. GLIDEWEAR® Patent No. 8,646,459</small>
--	--

EXTRA STRETCH-AIR OUTER COVER	
Regular:	One = \$125.00
(EM- <i>WWDD-CV</i>)	Two = \$250.00
with GlideWear:	One = \$150.00
(+CC-GLIDEWEAR)	Two = \$300.00

	INCONTINENCE LINER Liner provides extra incontinence protection for the cushion. Add at time of cushion purchase for only \$53.00. (INCON-LINER)
--	---

EXTRA INCONTINENCE LINER	
Off cushion:	One = \$120.00
(BINC-EM- <i>WWDD-CV</i>)	Two = \$240.00

WWDD to be replaced with sizes from table; *WW* - width in inches & *DD* - depth in inches

YOUR ORDER PART #

Please summarize your cushion style, size, and cover options here.

EM- _____

Example: EM-FAM-2018 for an Acta-Embrace ATI Anti-Thrust cushion with a Comfort-Tek cover.

ACTA-EMBRACE-ATI-ORDER CAN-JAN2022

2 EMBRACE ACCESSORIES

*All accessories are cosmetic changes to the cushion except for options in gray, which are add-on items.

2.1 GROWTH NOTCHES MSRP \$0.00

If growth notches are selected, a 1¼" wide cut will be taken from each side to allow the cushion to fit between the chair canes.

DEPTH OF NOTCHES

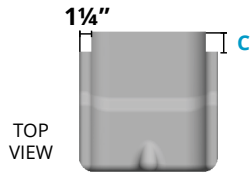

TOP VIEW

C = 1" D (GROWTH-NOTCH-1)

C = 2" D (GROWTH-NOTCH-2)

2.2 RAIL CUTS MSRP \$55.00

A standard 1 1/2" wide cut will be made and you decide how high the cut will need to be. All cuts run the entire depth of the cushion.

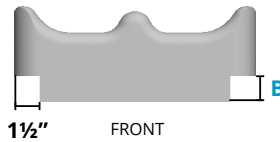

1 1/2" FRONT

B = 1" Rail Cut (RAIL-CUT-1.0)

B = 1 1/2" Rail Cut (RAIL-CUT-1.5)

B = 2" Rail Cut (RAIL-CUT-2.0)

2.3 COLOR - COMES STANDARD SILVER REFLECTIVE PIPING MSRP \$55.00

Accent colors can be applied to the cushion via colored piping. If no colors are selected, our standard silver reflective piping is used.

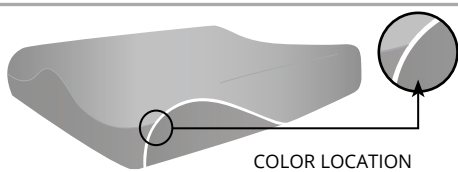

COLOR LOCATION

Red (RED)	Blue (BLUE)
Purple (PURPLE)	Green (GREEN)
Pink (PINK)	Remove (REMOVE)
Orange (ORANGE)	

2.4 REMOVABLE SOLID SEAT PAN & HARDWARE KIT MSRP \$657.00

The solid seat pan kit includes a slotted aluminum pan and attaching hardware to accommodate 7/8" or 1" tubing. The kit also comes with two different cross bars to accommodate various wheelchair frame types. This will fit both folding and non-folding seat rails. Lateral thigh support hardware can be easily attached.



Solid Seat Pan & Hardware Kit (RSSP-N-HARD)

3 BODILINK® LATERAL PELVIC/THIGH SUPPORT HARDWARE & PADS

Please select sizes in the appropriate fabric & style charts below. Contact Customer Support for custom sizes that are not listed below at 800.265.9830.

3.1 PREMIUM PAD MSRP \$142.00/ea.

- You may make one selection per column (Left, Extra Left, Right, and Extra Right) in section 3.1 for Premium Pads, or 3.3 for Basic Pads.
- Make a pad cover fabric selection in 3.2 or 3.4.

*Length (L) refers to the actual size dimension of the support from top to bottom edge. Depth (D) refers to the actual size dimension from anterior to posterior edge.

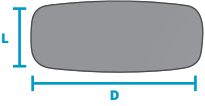
STYLE	SIZE	LEFT	EXTRA LEFT	RIGHT	EXTRA RIGHT
	3.5"L x 4"D	BL-LPTSP2Z-3L4D-LH	BL-LPTSP2Z-3L4D-LH	BL-LPTSP2Z-3L4D-RH	BL-LPTSP2Z-3L4D-RH
	3.5"L x 8"D	BL-LPTSP2Z-3L8D-LH	BL-LPTSP2Z-3L8D-LH	BL-LPTSP2Z-3L8D-RH	BL-LPTSP2Z-3L8D-RH
	3.5"L x 12"D	BL-LPTSP2Z-3L12D-LH	BL-LPTSP2Z-3L12D-LH	BL-LPTSP2Z-3L12D-RH	BL-LPTSP2Z-3L12D-RH
	5.5"L x 6"D	BL-LPTSP2Z-5L6D-LH	BL-LPTSP2Z-5L6D-LH	BL-LPTSP2Z-5L6D-RH	BL-LPTSP2Z-5L6D-RH

3.2 PREMIUM PAD COVER WITH FOAM INSERT

COMFORT-TEK
FOR FLUID PROTECTION & AN EASILY CLEANED SURFACE.

STRETCH-AIR
FOR PATIENT COMFORT & HEAT DISSIPATION.

GlideWear
FOR SKIN PROTECTION & SHEAR REDUCTION. NOT FLUID RESISTANT.

COVER OPTIONS	MSRP	LEFT	EXTRA LEFT	RIGHT	EXTRA RIGHT
COMFORT-TEK	\$0.00/ea.	LPTS-P2-COMFORT-FM	LPTS-P2-COMFORT-FM	LPTS-P2-COMFORT-FM	LPTS-P2-COMFORT-FM
STRETCH-AIR	\$0.00/ea.	LPTS-P2-STRETCH-FM	LPTS-P2-STRETCH-FM	LPTS-P2-STRETCH-FM	LPTS-P2-STRETCH-FM
GLIDEWEAR®	\$34.00/ea.	LPTS-P2-GLIDE-FM	LPTS-P2-GLIDE-FM	LPTS-P2-GLIDE-FM	LPTS-P2-GLIDE-FM

3.3 BASIC PAD MSRP \$132.00/ea.

*Length (L) refers to the actual size dimension of the support from top to bottom edge. Depth (D) refers to the actual size dimension from anterior to posterior edge.

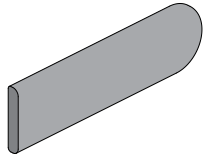
STYLE	SIZE	LEFT	EXTRA LEFT	RIGHT	EXTRA RIGHT
	3"L x 4"D	BL-LPTSP1Z-3L4D-LH	BL-LPTSP1Z-3L4D-LH	BL-LPTSP1Z-3L4D-RH	BL-LPTSP1Z-3L4D-RH
	3"L x 5"D	BL-LPTSP1Z-3L5D-LH	BL-LPTSP1Z-3L5D-LH	BL-LPTSP1Z-3L5D-RH	BL-LPTSP1Z-3L5D-RH
	4"L x 4"D	BL-LPTSP1Z-4L4D-LH	BL-LPTSP1Z-4L4D-LH	BL-LPTSP1Z-4L4D-RH	BL-LPTSP1Z-4L4D-RH
	4"L x 6"D	BL-LPTSP1Z-4L6D-LH	BL-LPTSP1Z-4L6D-LH	BL-LPTSP1Z-4L6D-RH	BL-LPTSP1Z-4L6D-RH
	4"L x 8"D	BL-LPTSP1Z-4L8D-LH	BL-LPTSP1Z-4L8D-LH	BL-LPTSP1Z-4L8D-RH	BL-LPTSP1Z-4L8D-RH
	4"L x 10"D	BL-LPTSP1Z-4L10D-LH	BL-LPTSP1Z-4L10D-LH	BL-LPTSP1Z-4L10D-RH	BL-LPTSP1Z-4L10D-RH
	4"L x 12" D	BL-LPTSP1Z-4L12D-LH	BL-LPTSP1Z-4L12D-LH	BL-LPTSP1Z-4L12D-RH	BL-LPTSP1Z-4L12D-RH
	4"L x 14" D	BL-LPTSP1Z-4L14D-LH	BL-LPTSP1Z-4L14D-LH	BL-LPTSP1Z-4L14D-RH	BL-LPTSP1Z-4L14D-RH
	4"L x 16" D	BL-LPTSP1Z-4L16D-LH	BL-LPTSP1Z-4L16D-LH	BL-LPTSP1Z-4L16D-RH	BL-LPTSP1Z-4L16D-RH
	5"L x 7" D	BL-LPTSP1Z-5L7D-LH	BL-LPTSP1Z-5L7D-LH	BL-LPTSP1Z-5L7D-RH	BL-LPTSP1Z-5L7D-RH

3.4 BASIC PAD COVER

COMFORT-TEK
FOR FLUID PROTECTION & AN EASILY CLEANED SURFACE.

STRETCH-AIR
FOR PATIENT COMFORT & HEAT DISSIPATION.

GlideWear
FOR SKIN PROTECTION & SHEAR REDUCTION. NOT FLUID RESISTANT.

COVER OPTIONS	MSRP	LEFT	EXTRA LEFT	RIGHT	EXTRA RIGHT
COMFORT-TEK	\$0.00/ea.	LPTS-P1-COMFORT	LPTS-P1-COMFORT	LPTS-P1-COMFORT	LPTS-P1-COMFORT
STRETCH-AIR	\$0.00/ea.	LPTS-P1-STRETCH	LPTS-P1-STRETCH	LPTS-P1-STRETCH	LPTS-P1-STRETCH
GLIDEWEAR®	\$34.00/ea.	LPTS-P1-GLIDE	LPTS-P1-GLIDE	LPTS-P1-GLIDE	LPTS-P1-GLIDE

3.5

BODILINK® LATERAL PELVIC/ THIGH SUPPORT HARDWARE

- You may make one selection per column (Left, Extra Left, Right, and Extra Right) in section 3.5 from group A, B, -OR- C.
- TT long extension arms will only work with TT style hardware.
- GT hardware extra links will only work with GT style hardware.

A. TT HARDWARE, SLOT MOUNT

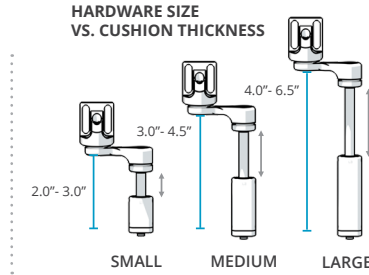
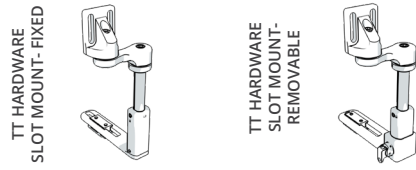

HARDWARE SIZE	MAX CUSHION THICKNESS CLEARANCE	RECOMMENDED CUSHION THICKNESS
SMALL	3.0"	2.0"- 3.0"
MEDIUM	4.5"	3.0"- 4.5"
LARGE	6.5"	4.0"- 6.5"

	SIZE	MSRP	LEFT				EXTRA LEFT				RIGHT				EXTRA RIGHT			
	FIXED	SMALL	\$207.00/ea.	BL-LPTS-TT1FXSL1-LH	BL-LPTS-TT1FXSL1-LH	BL-LPTS-TT1FXSL1-LH	BL-LPTS-TT1FXSL1-LH	BL-LPTS-TT1FXSL1-LH	BL-LPTS-TT1FXSL1-LH	BL-LPTS-TT1FXSL1-LH	BL-LPTS-TT1FXSL1-LH	BL-LPTS-TT1FXSL1-LH	BL-LPTS-TT1FXSL1-LH	BL-LPTS-TT1FXSL1-LH	BL-LPTS-TT1FXSL1-LH	BL-LPTS-TT1FXSL1-LH	BL-LPTS-TT1FXSL1-LH	BL-LPTS-TT1FXSL1-LH
	MEDIUM	\$207.00/ea.	BL-LPTS-TT1FXSL2-LH	BL-LPTS-TT1FXSL2-LH	BL-LPTS-TT1FXSL2-LH	BL-LPTS-TT1FXSL2-LH	BL-LPTS-TT1FXSL2-LH	BL-LPTS-TT1FXSL2-LH	BL-LPTS-TT1FXSL2-LH	BL-LPTS-TT1FXSL2-LH	BL-LPTS-TT1FXSL2-LH	BL-LPTS-TT1FXSL2-LH	BL-LPTS-TT1FXSL2-LH	BL-LPTS-TT1FXSL2-LH	BL-LPTS-TT1FXSL2-LH	BL-LPTS-TT1FXSL2-LH	BL-LPTS-TT1FXSL2-LH	BL-LPTS-TT1FXSL2-LH
	LARGE	\$207.00/ea.	BL-LPTS-TT1FXSL3-LH	BL-LPTS-TT1FXSL3-LH	BL-LPTS-TT1FXSL3-LH	BL-LPTS-TT1FXSL3-LH	BL-LPTS-TT1FXSL3-LH	BL-LPTS-TT1FXSL3-LH	BL-LPTS-TT1FXSL3-LH	BL-LPTS-TT1FXSL3-LH	BL-LPTS-TT1FXSL3-LH	BL-LPTS-TT1FXSL3-LH	BL-LPTS-TT1FXSL3-LH	BL-LPTS-TT1FXSL3-LH	BL-LPTS-TT1FXSL3-LH	BL-LPTS-TT1FXSL3-LH	BL-LPTS-TT1FXSL3-LH	BL-LPTS-TT1FXSL3-LH
OR																		
REMOVABLE	SMALL	\$296.00/ea.	BL-LPTS-TT1RMSL1-LH	BL-LPTS-TT1RMSL1-LH	BL-LPTS-TT1RMSL1-LH	BL-LPTS-TT1RMSL1-LH	BL-LPTS-TT1RMSL1-LH	BL-LPTS-TT1RMSL1-LH	BL-LPTS-TT1RMSL1-LH	BL-LPTS-TT1RMSL1-LH	BL-LPTS-TT1RMSL1-LH	BL-LPTS-TT1RMSL1-LH	BL-LPTS-TT1RMSL1-LH	BL-LPTS-TT1RMSL1-LH	BL-LPTS-TT1RMSL1-LH	BL-LPTS-TT1RMSL1-LH	BL-LPTS-TT1RMSL1-LH	BL-LPTS-TT1RMSL1-LH
	MEDIUM	\$296.00/ea.	BL-LPTS-TT1RMSL2-LH	BL-LPTS-TT1RMSL2-LH	BL-LPTS-TT1RMSL2-LH	BL-LPTS-TT1RMSL2-LH	BL-LPTS-TT1RMSL2-LH	BL-LPTS-TT1RMSL2-LH	BL-LPTS-TT1RMSL2-LH	BL-LPTS-TT1RMSL2-LH	BL-LPTS-TT1RMSL2-LH	BL-LPTS-TT1RMSL2-LH	BL-LPTS-TT1RMSL2-LH	BL-LPTS-TT1RMSL2-LH	BL-LPTS-TT1RMSL2-LH	BL-LPTS-TT1RMSL2-LH	BL-LPTS-TT1RMSL2-LH	BL-LPTS-TT1RMSL2-LH
	LARGE	\$296.00/ea.	BL-LPTS-TT1RMSL3-LH	BL-LPTS-TT1RMSL3-LH	BL-LPTS-TT1RMSL3-LH	BL-LPTS-TT1RMSL3-LH	BL-LPTS-TT1RMSL3-LH	BL-LPTS-TT1RMSL3-LH	BL-LPTS-TT1RMSL3-LH	BL-LPTS-TT1RMSL3-LH	BL-LPTS-TT1RMSL3-LH	BL-LPTS-TT1RMSL3-LH	BL-LPTS-TT1RMSL3-LH	BL-LPTS-TT1RMSL3-LH	BL-LPTS-TT1RMSL3-LH	BL-LPTS-TT1RMSL3-LH	BL-LPTS-TT1RMSL3-LH	BL-LPTS-TT1RMSL3-LH

B. TT HARDWARE, POWER MOUNT

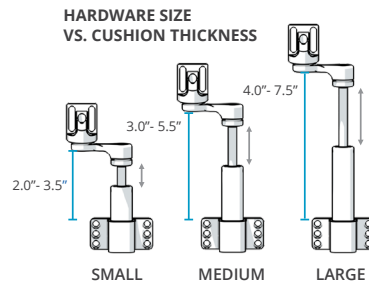
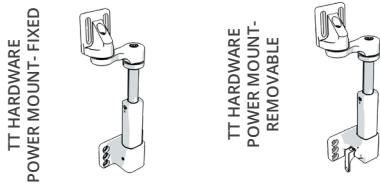

HARDWARE SIZE	MAX CUSHION THICKNESS CLEARANCE	RECOMMENDED CUSHION THICKNESS
SMALL	3.5"	2.0"- 3.5"
MEDIUM	5.5"	3.0"- 5.5"
LARGE	7.5"	4.0"- 7.5"

	SIZE	MSRP	LEFT				EXTRA LEFT				RIGHT				EXTRA RIGHT			
	FIXED	SMALL	\$268.00/ea.	BL-LPTS-TT1FXPWL1-LH	BL-LPTS-TT1FXPWL1-LH	BL-LPTS-TT1FXPWL1-LH	BL-LPTS-TT1FXPWL1-LH	BL-LPTS-TT1FXPWL1-LH	BL-LPTS-TT1FXPWL1-LH	BL-LPTS-TT1FXPWL1-LH	BL-LPTS-TT1FXPWL1-LH	BL-LPTS-TT1FXPWL1-LH	BL-LPTS-TT1FXPWL1-LH	BL-LPTS-TT1FXPWL1-LH	BL-LPTS-TT1FXPWL1-LH	BL-LPTS-TT1FXPWL1-LH	BL-LPTS-TT1FXPWL1-LH	BL-LPTS-TT1FXPWL1-LH
	MEDIUM	\$268.00/ea.	BL-LPTS-TT1FXPWL2-LH	BL-LPTS-TT1FXPWL2-LH	BL-LPTS-TT1FXPWL2-LH	BL-LPTS-TT1FXPWL2-LH	BL-LPTS-TT1FXPWL2-LH	BL-LPTS-TT1FXPWL2-LH	BL-LPTS-TT1FXPWL2-LH	BL-LPTS-TT1FXPWL2-LH	BL-LPTS-TT1FXPWL2-LH	BL-LPTS-TT1FXPWL2-LH	BL-LPTS-TT1FXPWL2-LH	BL-LPTS-TT1FXPWL2-LH	BL-LPTS-TT1FXPWL2-LH	BL-LPTS-TT1FXPWL2-LH	BL-LPTS-TT1FXPWL2-LH	BL-LPTS-TT1FXPWL2-LH
	LARGE	\$268.00/ea.	BL-LPTS-TT1FXPWL3-LH	BL-LPTS-TT1FXPWL3-LH	BL-LPTS-TT1FXPWL3-LH	BL-LPTS-TT1FXPWL3-LH	BL-LPTS-TT1FXPWL3-LH	BL-LPTS-TT1FXPWL3-LH	BL-LPTS-TT1FXPWL3-LH	BL-LPTS-TT1FXPWL3-LH	BL-LPTS-TT1FXPWL3-LH	BL-LPTS-TT1FXPWL3-LH	BL-LPTS-TT1FXPWL3-LH	BL-LPTS-TT1FXPWL3-LH	BL-LPTS-TT1FXPWL3-LH	BL-LPTS-TT1FXPWL3-LH	BL-LPTS-TT1FXPWL3-LH	BL-LPTS-TT1FXPWL3-LH
OR																		
REMOVABLE	SMALL	\$350.00/ea.	BL-LPTS-TT1RMPWL1-LH	BL-LPTS-TT1RMPWL1-LH	BL-LPTS-TT1RMPWL1-LH	BL-LPTS-TT1RMPWL1-LH	BL-LPTS-TT1RMPWL1-LH	BL-LPTS-TT1RMPWL1-LH	BL-LPTS-TT1RMPWL1-LH	BL-LPTS-TT1RMPWL1-LH	BL-LPTS-TT1RMPWL1-LH	BL-LPTS-TT1RMPWL1-LH	BL-LPTS-TT1RMPWL1-LH	BL-LPTS-TT1RMPWL1-LH	BL-LPTS-TT1RMPWL1-LH	BL-LPTS-TT1RMPWL1-LH	BL-LPTS-TT1RMPWL1-LH	BL-LPTS-TT1RMPWL1-LH
	MEDIUM	\$350.00/ea.	BL-LPTS-TT1RMPWL2-LH	BL-LPTS-TT1RMPWL2-LH	BL-LPTS-TT1RMPWL2-LH	BL-LPTS-TT1RMPWL2-LH	BL-LPTS-TT1RMPWL2-LH	BL-LPTS-TT1RMPWL2-LH	BL-LPTS-TT1RMPWL2-LH	BL-LPTS-TT1RMPWL2-LH	BL-LPTS-TT1RMPWL2-LH	BL-LPTS-TT1RMPWL2-LH	BL-LPTS-TT1RMPWL2-LH	BL-LPTS-TT1RMPWL2-LH	BL-LPTS-TT1RMPWL2-LH	BL-LPTS-TT1RMPWL2-LH	BL-LPTS-TT1RMPWL2-LH	BL-LPTS-TT1RMPWL2-LH
	LARGE	\$350.00/ea.	BL-LPTS-TT1RMPWL3-LH	BL-LPTS-TT1RMPWL3-LH	BL-LPTS-TT1RMPWL3-LH	BL-LPTS-TT1RMPWL3-LH	BL-LPTS-TT1RMPWL3-LH	BL-LPTS-TT1RMPWL3-LH	BL-LPTS-TT1RMPWL3-LH	BL-LPTS-TT1RMPWL3-LH	BL-LPTS-TT1RMPWL3-LH	BL-LPTS-TT1RMPWL3-LH	BL-LPTS-TT1RMPWL3-LH	BL-LPTS-TT1RMPWL3-LH	BL-LPTS-TT1RMPWL3-LH	BL-LPTS-TT1RMPWL3-LH	BL-LPTS-TT1RMPWL3-LH	BL-LPTS-TT1RMPWL3-LH

TT HARDWARE, POWER MOUNT OPTION

NOTE: If choosing the Power Mount Hardware, choose the appropriate power mount type below.

POWER MOUNT	MSRP	PART NUMBER
QUANTUM	add \$0.00	LPTS-TT1-PW1
PERMOBIL	add \$0.00	LPTS-TT1-PW2
QUICKIE	add \$0.00	LPTS-TT1-PW3
ROVI	add \$0.00	LPTS-TT1-PW4
AVID REHAB	add \$0.00	LPTS-TT1-PW5

TT LONG EXTENSION ARM 4"

MSRP \$55.00/arm

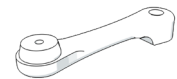

LEFT	EXTRA LEFT	RIGHT	EXTRA RIGHT
BL-LPTS-TT1LARM4	BL-LPTS-TT1LARM4	BL-LPTS-TT1LARM4	BL-LPTS-TT1LARM4

C. GT HARDWARE, ONLY SLOT MOUNT

GT HARDWARE
SLOT MOUNT- FIXED



GT HARDWARE
SLOT MOUNT-
REMOVABLE

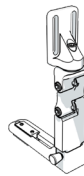

NO MEDIAL

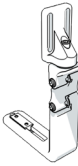

1" MEDIAL



HARDWARE	MAX CUSHION THICKNESS CLEARANCE	RECOMMENDED CUSHION THICKNESS
NO MEDIAL	*5.0"	2.5"- 5.0"
1" MEDIAL	*4.0"	2.25"- 4.0"

*If you need to increase the height or medial reach, add additional links below.

SIZE	MSRP	LEFT	EXTRA LEFT	RIGHT	EXTRA RIGHT
FIXED	\$207.00/ea.	BL-LPTS-GT2FXS-LH	BL-LPTS-GT2FXS-LH	BL-LPTS-GT2FXS-RH	BL-LPTS-GT2FXS-RH
REMOVABLE	\$247.00/ea.	BL-LPTS-GT2RMS-LH	BL-LPTS-GT2RMS-LH	BL-LPTS-GT2RMS-RH	BL-LPTS-GT2RMS-RH

ADDITIONAL GT OPTIONS

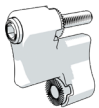

GT ADDITIONAL HARDWARE LINKS	LEFT	EXTRA LEFT	RIGHT	EXTRA RIGHT
MSRP \$55.00/link (2 Additional 1.25" Links Allowed Per Hardware Ordered)	BL-LPTS-GT2LINK	BL-LPTS-GT2LINK	BL-LPTS-GT2LINK	BL-LPTS-GT2LINK
	BL-LPTS-GT2LINK	BL-LPTS-GT2LINK	BL-LPTS-GT2LINK	BL-LPTS-GT2LINK

4 BODILINK® MEDIAL KNEE/THIGH SUPPORT HARDWARE & PADS

4.1 PAD SIZE & SHAPE

MSRP \$193.00/ea.

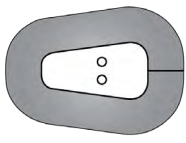
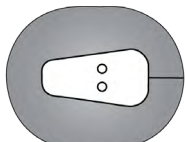
STYLE	SIZE	PART NUMBER
 WEDGE	2.5"W x 3.5"D	BL-MKTSP1-3W4D
	3.5"W x 5"D	BL-MKTSP1-4W5D
	4"W x 6"D	BL-MKTSP1-4W6D
 OVAL	2.5"W x 3.5"D	BL-MKTSP2-3W4D
	3.5"W x 5"D	BL-MKTSP2-4W5D
	5"W x 6"D	BL-MKTSP2-5W6D

4.2 PAD COVER MATERIAL

- You may make one selection per column.
- Choose between wedge or oval in 4.1.
- Choose a cover material in 4.2.
- Choose hardware size in 4.3.

GlideWear
INNOVATIVE SKIN PROTECTION

FOR SKIN PROTECTION & SHEAR REDUCTION. NOT FLUID RESISTANT.

COMFORT-TEK



FOR FLUID PROTECTION & AN EASILY CLEANED SURFACE.

STRETCH-AIR



FOR PATIENT COMFORT & HEAT DISSIPATION.

GlideWear™ (MKTSP-GLIDE) (add \$34.00)

COMFORT-TEK (MKTSP-COMFORT)

STRETCH-AIR (MKTSP-STRETCH)

4.3 MEDIAL KNEE/THIGH SUPPORT SWING-AWAY HARDWARE

MSRP \$266.00/ea.

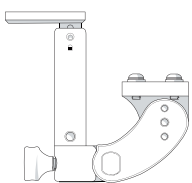

SIZE	PART NUMBER
SMALL	BL-MKTS-ST1SASL1
MEDIUM	BL-MKTS-ST1SASL2
LARGE	BL-MKTS-ST1SASL3

- *Swing-Away Hardware only, not available in Fixed Hardware
- **MKTS Hardware must be mounted to Removable Solid Seat Pan in section 2.4
- ***If Leg Length Discrepancy is needed on Removable Solid Seat Pan, Offset Orientation must be selected

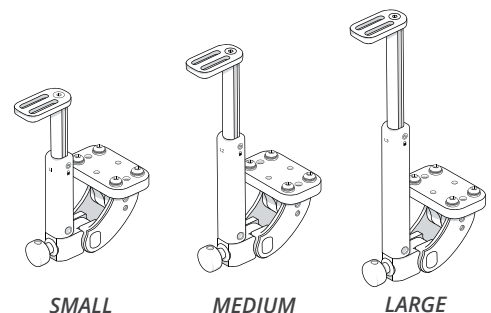
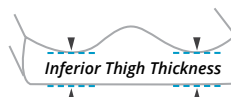

SMALL

MEDIUM

LARGE

SIZE	RECOMMENDED INFERIOR THIGH THICKNESS
Small	1.00"- 3.00"
Medium	2.00"- 5.00"
Large	3.00"- 7.00"