



Date ..... Order ..... User ..... Address .....

### CUSTOMIZE COLORS

- ① Fork colour**  
 ☆ Opaque black  
 Bright silver  
 POLAR white  
 Bright red  
 Tekno anthracite  
 Matt grey
- Bright blue  
 Bright fuchsia  
 Bright lime  
 Matt Midnight blue  
 Matt red

08342 68,00

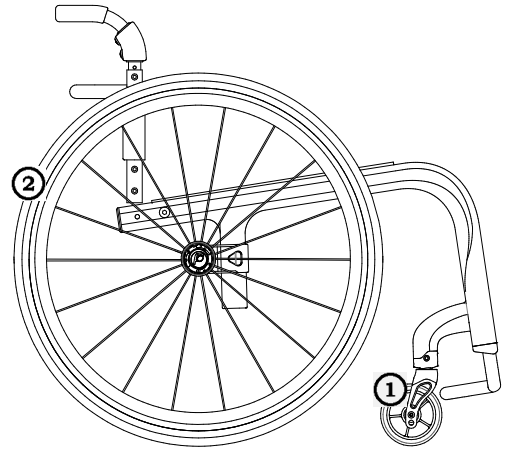

- ② Colour rear wheels**  
 To be matched only with: Rear wheels Ultra-light Progeo - Standard! (22 - 24)  
 ☆ Black  
 Bright silver  
 POLAR white  
 Bright red  
 Tekno anthracite  
 Matt grey
- Bright blue  
 Bright fuchsia  
 Bright lime  
 Matt Midnight blue  
 Matt red

04692 68,00



### Rear wheels axle

- ☆ Aluminum rear wheels axle  
 Carbon fiber rear wheels axle *Lightest configuration* **07647 158,00**

### Backrest adjustment and fixing system

- ☆ Backrest with double locking (upright and folded) **with rake adjustable from -4° to +16°**  
 Backrest with upright locking system ONLY (no locking when folded) **with rake adjustable from -4° to +16°**  
 Fixed back(non-folding back) **with rake adjustable from -4° to +16°**



### Backrest

- ☆ Adjustable velcro straps and padded transpiring upholstery
- ☆ Aluminium backrest  **06811 203,00**  
 Titanium backrest   
 Carbon fibre backrest  **04389 802,00**



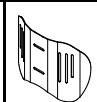
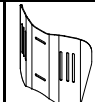
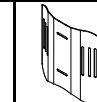
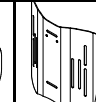

**AIR**  **Integrated posture backrest (NOT REMOVABLE)**

Carbon shell - Lateral retaining 7,5cm  
 Depth adjustment ±1cm. - Angle adjustment ±10°  
 not available for seat width 48

**1.121,00**

H 28		H 34		H 40	
Backrest Height (TS) min 34 ( ..... )		Backrest Height (TS) min 38 ( ..... )		Backrest Height (TS) min 44 ( ..... )	
Lateral retaining wing A=high - R=regular					
A	R	A	R	A	R
					
<input type="checkbox"/>	<input type="checkbox"/>	<input type="checkbox"/>	<input type="checkbox"/>	<input type="checkbox"/>	<input type="checkbox"/>

### Installation on:

- ☆ Backrest tubes   
 Aluminium backrest   
 Titanium backrest  **06811 203,00**  
 Carbon fibre backrest  **04389 802,00**



### Handle tube

- ☆ Tubes with standard handle  
 Tubes with short handle  
 SPORT tubes Without push handles  
 Carbon fibre tubes with short handle *Weight reduction approx. 110gr.* **04390 158,00**  
**Not available with: Posture backrest PHYSIO - Posture backrest A I R**  
 Folding handles *Minimum backrest height 30,5cm*  **02958 270,00**  
 Not available with: Push handles for companion

Date .....	Order .....	User .....	Address .....
------------	-------------	------------	---------------

**Footplate**

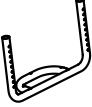
☆ Aluminium footplate. Rake not adjustable

☆ WITHOUT plastic plate   with plastic plate 

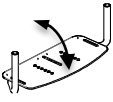
One piece aluminium footplate - Flip-up! FLIP-BACK! - rake and depth adjustable  
 IMPORTANT NOTICE! From the footplate to the floor minimum 6cm !! (Minimum Front height = DP + 4cm)  
 With 5" front wheel the difference between Front Height and Rear Height must be greater than 5cm  **09420 203,00**

Aluminium footplate, rake and depth adjustable

☆ Internal  2/3 Internal  External  2/3 External  **04456 270,00**

U-TUBE - Aluminium footplate, rake and depth adjustable  
**LOW FRAME: minimum footplate distance 18 - maximum footplate distance 35**  
**HIGH FRAME: minimum footplate distance 21 - maximum footplate distance 38**  **09853 240,00**

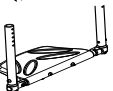
One piece Carbon fibre footplate. Rake adjustable  **04110 398,00**

☆ Internal  External

**Mudguard**

☆ Carbon fibre mudguard  
 Carbon fibre Straight sideguard

**Mudguard enlargement**

☆ + 0 cm **12648**  
 + 1 cm

Removable version  **08921 135,00**  
*The distance between the two side guards is 1 cm wider than the seat width*

**Casters**

☆ 4" Soft

3" Sport *Lightest configuration*

5" Soft

3" Active Soft (wide) (Aluminium alloy rim) **06824 95,00**  
 4" Active Sport (narrow) (Aluminium alloy rim) **01398 95,00**  
 4" Active Soft (wide) (Aluminium alloy rim) **03943 95,00**  
 5" Active Soft (wide) (Aluminium alloy rim) **07518 95,00**  
 5" Pneumatic **10844 68,00**

**Rear wheels**

☆ 24" Ultra-light Progeo - Standard!

22" Ultra-light Progeo - Standard!  
 25" Ultra-light Progeo - Standard! (colour: black)  
 26" Progeo - Standard! (colour: black)

24" ULTRA-LIGHT PROGEO KEY SPORT *Lightest configuration* **04383 695,00**  
 24" Ultra-light "Spinergy LX" **01685 695,00**  
 24" Ultra-light "Spinergy LXL"  Black hub and white spokes  Hub and spokes black **07846 695,00**  
 24" Ultra-light "Spinergy Flex rim" Integrated aluminium/rubber handrim **02270 1.150,00**  
 25" Ultra-light "Spinergy LX" **02101 695,00**  
 25" Ultra-light "Spinergy LXL"  Black hub and white spokes **07847 695,00**  
 26" Ultra-light "Spinergy LX" **02102 695,00**  
 24" Off-road (aluminium handrim black - Wheel distance 4cm) **01392 270,00**

**Rear wheel tyre**

☆ High pressure tyre (22"-24"-25"-26") *Lightest configuration*

High pressure profile tyre (24")

Marathon Plus (24"-25") with anti-puncture protection **01669 95,00**







Anti-puncture - Colour Grey (22") **04181 105,00**



Anti-puncture - Colour Black (24") **11083 95,00**

**Not available with Rear wheels : 24" ULTRA-LIGHT PROGEO KEY SPORT, 24" Ultra-light "Spinergy LXL"**



Date .....	Order .....	User .....	Address .....
------------	-------------	------------	---------------



Handrim	Wheel distance ☆ 3 cm    □ 4 cm		09170	160,00
☆ Aluminium	(22"-24"-25"-26")	<i>Lightest configuration</i>		
<input type="radio"/> Aluminium black SOFT-TOUCH	(24"-25")	(24" handrim, on 25" wheel is installed with spacers)	01684	160,00
<input type="radio"/> Chromed Steel	(24"-25")	(24" handrim, on 25" wheel is installed with spacers)	00016	290,00
<input type="radio"/> Titanium	(24"-25")	(24" handrim, on 25" wheel is installed with spacers)	00017	290,00
<input type="radio"/> Ultra Grepp	(24"-25")	(24" handrim, on 25" wheel is installed with spacers)		
<input type="radio"/> TOP FRICTION	(24"-25")	(24" handrim, on 25" wheel is installed with spacers)	11023	290,00
Oval countour with a rubber insert				
<input type="radio"/> NOVA H	(24"-25")	(24" handrim, on 25" wheel is installed with spacers)	11025	290,00
Ergonomic black profile				
<input type="radio"/> NOVA D	(24"-25")	(24" handrim, on 25" wheel is installed with spacers)	11026	290,00
Ergonomic profile with rubber coating (ideal for quadriplegics)				
<input type="radio"/> Silicon cover for standard aluminium handrim		Available for measures (22"- 24" - 26")	04050	172,00

Wheel locks				
☆ Bent lever push to lock				
<input type="checkbox"/> Straight lever push to lock				
<input type="checkbox"/> Straight lever pull to lock				
<input type="radio"/> Sport brake			06428	135,00
<input type="radio"/> Brake with extension lever push to lock			01949	68,00
<input type="radio"/> Brake with extension lever pull to lock			03372	68,00

Armrests				
<input type="radio"/> Tubular armrests	(Swing away, removable and height adjustable armrest)		00694	270,00
<input type="radio"/> Removable armrest with carbon-fiber straight sideguard	<i>The distance between the two side guards is 1 cm wider than the seat width</i>		09079	240,00

Accessories				
<input type="radio"/> Pad for front frame protectors			07058	56,00
<input type="radio"/> Backrest-seat connection cloth			10241	25,00
<input type="radio"/> Removable storage bag (with quick coupling)			09811	135,00

Optional 1				
<u>Only one optional devices for side can be chosen</u>				
<input type="radio"/> Transit wheels	Exclude the installation of Anti-tippers		03290	158,00
<input type="radio"/> Anti-tipper with rapid hookup	Exclude the installation of Transit wheels (inside rotation to reduce the encumbrance)		06821	145,00
	<input type="radio"/> Right		06822	145,00
	<input type="radio"/> Left			

Optional 2				
<input type="radio"/> Push handles for companion	(Removable and height adjustable)		03645	189,00
<input type="radio"/> Tetraclip	(Quick release axle for quadriplegic)		03947	189,00
<input type="radio"/> Safety pelvic belt			03972	68,00
<input type="radio"/> Harness			04103	145,00
<input type="radio"/> Lumbar support	(to insert in the backrest upholstery)		00013	43,00
<input type="radio"/> Swing away lateral support	Not available with Posture backrest PHYSIO - Posture backrest A I R		02097	270,00
Prevents backrest folding	<input type="radio"/> Right		02098	270,00
	<input type="radio"/> Left			
<input type="radio"/> Spoke guards Black	(22"-24")		01043	158,00
<input type="radio"/> Spoke guards Transparent	(22"-24")		00835	158,00
<input type="radio"/> Spoke guards Progeo design	(22"-24")		00019	189,00

Additional Kit				
<input type="radio"/> 24" Off-road rear wheels	Off-Road tyre - aluminium handrim (black colour)		03378	534,00
<input type="radio"/> 24" FAT rear wheels	FAT tyre 3" - aluminium handrim (black colour)		09357	895,00

Permobil Limited Unit 7, Polaris Centre, 41 Brownfields, Welwyn Garden City, Herts, AL7 1AN United Kingdom - Phone: +44 1484 722888



customer\_support\_uk@permobil.com - https://www.permobil.com/en-gb

Date ..... Order ..... User ..... Address .....

### PHYSIO - Posture backrest (Std. Backrest upholstery not provided)

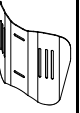
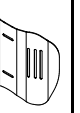

Removable with quick release  
Suitable for tubes with diameter 18+26mm  
Depth adjustment (4cm)  
Angle adjustment (±18°)

- AIR** Carbon shell  
not available for seat width 48

BACKREST HEIGHT	28	34	40	
Shell's shape 	Lateral retaining wing A=high - R=regular			
	A	R	A	R
				
	<input type="checkbox"/>	<input type="checkbox"/>	<input type="checkbox"/>	<input type="checkbox"/>

1.121,00

- POSTURE** Aluminum shell

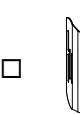
BACKREST HEIGHT	34	40	52	
Shell's shape 	Lateral retaining wing R=regular			
	R	R	R	
				
	<input type="checkbox"/>	<input type="checkbox"/>	<input type="checkbox"/>	

1.085,00

### Configuration DEEP with side support PAD (height adjustable)

Alluminum lateral with padded, breathable upholstery.



- Right 10272
- Left 10272

49,00  
49,00



- Right 10273
- Left 10273

49,00  
49,00

### SWING AWAY - Lateral support

Fixing and adjustment hardware complete with protection sleeve  
Alluminum lateral with padded, breathable upholstery.

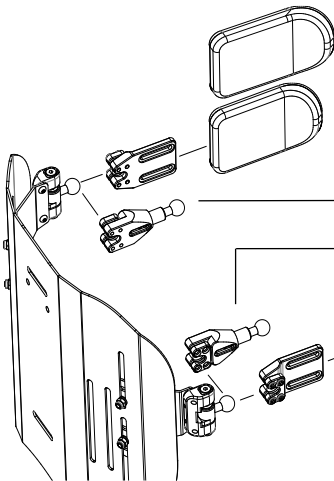

- Large (18x12)
- Small (14x9)
- Lateral support extension
- Lateral support extension
- Small (14x9)
- Large (18x12)

05647 196,00  
05643 196,00  
10271 74,00  
05642 196,00  
05646 196,00

- Headrest adjustable - Double ball mounting system

Available only with backrest Physio Posture



- Large (35x12,5) 05648 385,00
- Small (25x12,5)

Date .....	Order .....	User .....	Address .....
------------	-------------	------------	---------------





Note

<b>Wheelchair : Progeo DUKE - Rev. 2026.0</b>	<b>Prices - VAT excluded</b> <small>to be added to the price list</small>	<table border="1" style="width: 100%; border-collapse: collapse;"> <tr> <td colspan="2" style="text-align: center; font-weight: bold; font-size: small;">Send this page only if any optional have been chosen</td> </tr> <tr> <td style="width: 10%; text-align: center; font-size: x-small;">☆</td> <td style="font-size: x-small;"> <b>standard</b> <small>(supplied if no requests are indicated)</small> </td> </tr> <tr> <td style="text-align: center; font-size: x-small;">□</td> <td style="font-size: x-small;"> <b>on request</b> <small>(without extra charge)</small> </td> </tr> <tr> <td style="text-align: center; font-size: x-small;">○</td> <td style="font-size: x-small;"> <b>optional</b> <small>(cost to be added at the basic price)</small> </td> </tr> </table>	Send this page only if any optional have been chosen		☆	<b>standard</b> <small>(supplied if no requests are indicated)</small>	□	<b>on request</b> <small>(without extra charge)</small>	○	<b>optional</b> <small>(cost to be added at the basic price)</small>
Send this page only if any optional have been chosen										
☆	<b>standard</b> <small>(supplied if no requests are indicated)</small>									
□	<b>on request</b> <small>(without extra charge)</small>									
○	<b>optional</b> <small>(cost to be added at the basic price)</small>									

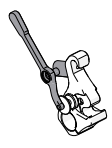
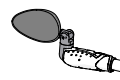

Date ..... Order ..... User ..... Address .....

### Accessories

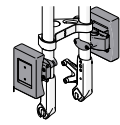
- |   |   |   |        |        |
|---|---|---|--------|--------|
| <input type="radio"/> FULL LED light (high intensity)<br>Integrated in the spoiler  |  | 10908   | 107,00 |        |
| <input type="radio"/> Handlebar extension<br>Adjustable from 15cm up to 23cm  |  | 10907   | 182,00 |        |
| <input type="radio"/> Motor unit facilitated unlock lever<br>Recommended with handlebar for quadriplegic  |  | 10915   | 82,00  |        |
| <input type="radio"/> Additional FLY 48V - 2.9 Ah battery<br>Autonomy up to 15km<br>Approved for air transport  |   | 10906   | 697,00 |        |
| <input type="radio"/> Rearview mirror   | <input type="radio"/> Right<br><input type="radio"/> Left                           |    | 10909  | 32,00  |
|   |   |   | 10909  | 32,00  |
| <input type="radio"/> Basket (removable) - (with KLICKfix® attachment system)   |   |   | 10912  | 212,00 |
| <input type="radio"/> Removable front weight - (with KLICKfix® attachment system)<br>(it increases the weight over the power wheel to improve traction) |   |  | 10910  | 311,00 |
| <input type="radio"/> Travel bag  |   |   | 10916  | 155,00 |

### Note

Send this page only if any optional have been chosen

- |                                     |            |   |
|-------------------------------------|------------|---|
| <input checked="" type="checkbox"/> | standard   | (supplied if no requests are indicated) |
| <input type="checkbox"/>            | on request | (without extra charge)                  |
| <input type="radio"/>               | optional   | (cost to be added at the basic price)   |

Wheelchair : Progeo DUKE - Rev. 2026.0

Prices - VAT excluded  
to be added to the price list