

Permobil Limited Unit 7, Polaris Centre, 41 Brownfields, Welwyn Garden City, Herts. AL7 1AN United Kingdom - Phone: +44 1484 722888

UK (English)

Date

User

End user weight (kg)

Language user manual

Company stamp

Responsible

CRASH TEST APPROVED

Folding frame wheelchair

£ 2000,00
Retail price - VAT not included

Wheelchair measures - The tolerance on all the dimensions indicated and/or required is ± 10 mm

Seat width (LS) 33 36 39 42 45 48
The seat width is measured from the outer sides of the frame
For seat enlargement see section enlargement of mudguard and armrest with integrated mudguard
 Seat depth (PS) 35 37,5 40 42,5 45 47,5 50
 Footplate distance (DP) (cm) ±0.5cm - adjustment steps 1.5cm
(Real distance between seat and footplate) - IMPORTANT NOTICE! From the footplate to the floor minimum 4cm !! (Minimum Front height = DP + 4cm)

Setting ☆ Standard Prudential Active Extreme

Backrest Height (TS) Std. Value 36 (min 30-max 54) adjustment steps 1.5cm

Crossbrace (black) ☆ Single Double (Not seat width 33-36)

Front height (STD 49) - Rear height (STD 44)

SAFETY

4 points tie-down system rings
NOT AVAILABLE WITH: Aluminium frame DYNAMIC 2.0 - Titanium frame T MAX
 (installation must be carried out by the manufacturer)
 A head restraint suitable for transportation must be available and fitted accordingly during transportation.



08654 **203,00**

Rear frame

Aluminium frame

☆ Aluminium standard frame - Same colour of front frame

The real seat depth, from the front part of the seat cloth to the backrest tube will be 1 cm more than the declared one.

camber
 ☆ 0° 1,5° 3°

Aluminium frame DYNAMIC 2.0 - (COLOUR: BLACK) **09955 337,00**

The real seat depth, from the front part of the seat cloth to the backrest tube will be 1,5 cm more than the declared one.
With rake adjustable backrest (±9°)
Exclude the installation of : Brake handles for companion (Drum Brake) - 4 points tie-down system rings

camber
 ☆ 0° 1,5° 2° 4°

Front frame

Short frame - Ideal with Seat depth (PS) 35 - 37,5
Not available for depth 45 - 47,5

Medium frame - Ideal with Seat depth (PS) 40 - 42,5
Not available for depth 47,5

Long frame - Ideal with Seat depth (PS) 45 - 47,5

Frame Angle

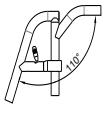
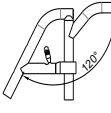
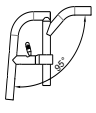
☆ 110° 120° 95°

Elevating front frame, swing away and removable
Include calf supports and plastic footrest with heel band
(not available for seat width 33)
Minimum footplate distance 25cm.

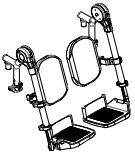

09730 **270,00**

Frame colour

Frame colour (without extra charge)

<input checked="" type="checkbox"/> Opaque black	<input type="checkbox"/> Tekno anthracite	<input type="checkbox"/> Matt grey
<input type="checkbox"/> POLAR white	<input type="checkbox"/> Matt Midnight blue	<input type="checkbox"/> Matt red

Frame colour on request

<input type="checkbox"/> Bright silver	<input type="checkbox"/> Bright fuchsia	<input type="checkbox"/> Bright blue china
<input type="checkbox"/> Bright blue	<input type="checkbox"/> Bright lime	<input type="checkbox"/> Bright red

12579 109,00

Backrest

☆ Adjustable velcro straps and padded transpiring upholstery

customer_support_uk@permobil.com - https://www.permobil.com/en-gb

Date	Order	User	Address
------------	-------------	------------	---------------

Handle tube			
<input checked="" type="checkbox"/> Tubes with standard handle			
<input type="checkbox"/> Folding handles			02958 270,00
<small>Not available with: Push handles for companion, Brake handles for companion (Drum Brake)</small>			

Colour set: Includes rear wheel hub and rim, rear wheel plates and front forks			
<small>Only standard Progeo 22"/24" wheels have coloured hubs and rims</small>			
<input checked="" type="checkbox"/> Black	22" 24" 25" 26"		
<input type="checkbox"/> Bright silver	22" 24"	00833	135,00
<input type="checkbox"/> Bright lime	22" 24"	00833	135,00
<input type="checkbox"/> Bright blue	22" 24"	00833	135,00
<input type="checkbox"/> Bright red	22" 24"	00833	135,00
<input type="checkbox"/> Bright fuchsia	22" 24"	00833	135,00
<input type="checkbox"/> POLAR white	22" 24"	00833	135,00
<input type="checkbox"/> Tekno anthracite	22" 24"	00833	135,00
<input type="checkbox"/> Matt Midnight blue	22" 24"	00833	135,00
<input type="checkbox"/> Matt grey	22" 24"	00833	135,00
<input type="checkbox"/> Matt red	22" 24"	00833	135,00







Casters			
<input checked="" type="checkbox"/> 5" Soft			
<input type="checkbox"/> 4" Soft			
<input type="checkbox"/> 3" Sport			
<input type="checkbox"/> 6" Soft	<i>Lightest configuration</i>		
<input type="checkbox"/> 6" Pneumatic	<small>Not available with frame angle 95°</small>		
<input type="checkbox"/> 7" Soft	<small>Not available with frame angle 95°</small>		
<input type="checkbox"/> 3" Active Soft (wide)	(Aluminium alloy rim)	06824	95,00
<input type="checkbox"/> 4" Active Sport (narrow)	(Aluminium alloy rim)	01398	95,00
<input type="checkbox"/> 4" Active Soft (wide)	(Aluminium alloy rim)	03943	95,00
<input type="checkbox"/> 5" Active Soft (wide)	(Aluminium alloy rim)	07518	95,00
<input type="checkbox"/> 5" Pneumatic		10844	68,00





Rear wheels			
<input checked="" type="checkbox"/> 24" Ultra-light Progeo - Standard!			
<input type="checkbox"/> 22" Ultra-light Progeo - Standard!			
<input type="checkbox"/> 25" Ultra-light Progeo - Standard!	(colour: black)		
<input type="checkbox"/> 26" Progeo - Standard!	(colour: black)		
<input type="checkbox"/> 24" ULTRA-LIGHT PROGEO KEY SPORT	<i>Lightest configuration</i>	04383	695,00
<input type="checkbox"/> 24" Ultra-light "Spinergy LX"		01685	695,00
<input type="checkbox"/> 24" Ultra-light "Spinergy LXL"	<input type="checkbox"/> Black hub and white spokes	07846	695,00
<input type="checkbox"/> 24" Ultra-light "Spinergy Flex rim"	<input type="checkbox"/> Integrated aluminium/rubber handrim	02270	1.150,00
<input type="checkbox"/> 25" Ultra-light "Spinergy LX"		02101	695,00
<input type="checkbox"/> 25" Ultra-light "Spinergy LXL"	<input type="checkbox"/> Black hub and white spokes	07847	695,00
<input type="checkbox"/> 26" Ultra-light "Spinergy LX"		02102	695,00
<input type="checkbox"/> 24" Off-road (aluminium handrim black - Wheel distance 4cm)		01392	270,00
<input type="checkbox"/> 24" with brake handles for companion (drum brake) (aluminium handrim - Wheel distance 3cm)		03384	386,00
<small>Available only with camber 0° Not available with Frame Dynamic 2.0</small>			
<input type="checkbox"/> One arm drive - (24" rear wheels Aluminium handrim High pressure Tyre) - camber 0°	<input type="checkbox"/> Right <input type="checkbox"/> Left	02103	430,00



Rear wheel tyre			
<input checked="" type="checkbox"/> High pressure tyre	(22"-24"-25"-26")	<i>Lightest configuration</i>	
<input type="checkbox"/> High pressure profile tyre	(24")		
<input type="checkbox"/> Marathon Plus	(24"-25")	with anti-puncture protection	01669 95,00
<input type="checkbox"/> Anti-puncture - Colour Black	(24")		11083 95,00
<small>Not available with Rear wheels : 24" ULTRA-LIGHT PROGEO KEY SPORT, 24" Ultra-light "Spinergy LXL"</small>			
<input type="checkbox"/> Anti-puncture - Colour Grey	(22")		04181 105,00

Date	Order	User	Address
------------	-------------	------------	---------------

Handrim	Wheel distance ☆ 3 cm □ 4 cm			
☆ Aluminium	(22"-24"-25"-26")	<i>Lightest configuration</i>		
<input type="radio"/> Aluminium black SOFT-TOUCH	(24"-25")	(24" handrim, on 25" wheel is installed with spacers)	09170	160,00
<input type="radio"/> Chromed Steel	(24"-25")	(24" handrim, on 25" wheel is installed with spacers)	01684	160,00
<input type="radio"/> Titanium	(24"-25")	(24" handrim, on 25" wheel is installed with spacers)	00016	290,00
<input type="radio"/> Ultra Grepp	(24"-25")	(24" handrim, on 25" wheel is installed with spacers)	00017	290,00
<input type="radio"/> TOP FRICTION Oval countour with a rubber insert	(24"-25")	(24" handrim, on 25" wheel is installed with spacers)	11023	290,00
<input type="radio"/> NOVA H Ergonomic black profile	(24"-25")	(24" handrim, on 25" wheel is installed with spacers)	11025	290,00
<input type="radio"/> NOVA D Ergonomic profile with rubber coating (ideal for quadriplegics)	(24"-25")	(24" handrim, on 25" wheel is installed with spacers)	11026	290,00
<input type="radio"/> Silicon cover for standard aluminium handrim	Available for measures (22" - 24" - 26")		04050	172,00

Wheel locks				
<input checked="" type="radio"/> Bent lever push to lock				
<input type="checkbox"/> Straight lever push to lock				
<input type="checkbox"/> Straight lever pull to lock				
<input type="radio"/> Sport brake		06428	135,00	
<input type="radio"/> Brake with extension lever push to lock		01949	68,00	
<input type="radio"/> Brake with extension lever pull to lock		03372	68,00	







Footplate (Not available with Elevating front frame, swing away and removable) - See reference tables N°3				
☆ Plastic footrest, rake adjustable Not available with Elevating front frame, swing away and removable Minimum footplate distance 27cm.	☆ 2/3 Internal □ 2/3 External		11525	
<input type="checkbox"/> One piece footplate - Flip-up! rake and depth adjustable Not available with Elevating front frame, swing away and removable Minimum footplate distance 26cm.	<input type="checkbox"/> Internal ☆ 2/3 Internal □ External		11527	
<input type="radio"/> Minimum footplate distance 21cm. Available only with Multi-function and rotative system - 03945	203,00			
<input type="checkbox"/> One piece aluminium footplate - Flip-up! rake and depth adjustable Not available with Elevating front frame, swing away and removable Minimum footplate distance 26cm.	<input type="checkbox"/> Internal ☆ 2/3 Internal □ 2/3 External □ External		11528	
<input type="radio"/> One piece Carbon fibre footplate rake adjustable, swing away, flip-up. Not available with Elevating front frame, swing away and removable Minimum footplate distance 26cm.	☆ Internal □ External		03291	294,00

Mudguard				
Mudguard - FIXED				
☆ ABS mudguard			03946	337,00
<input type="checkbox"/> ABS Straight sideguard			08918	337,00
<input type="radio"/> Carbon fibre mudguard				
<input type="radio"/> Carbon fibre Straight sideguard				
<input type="checkbox"/> Mudguard enlargement				
☆ + 0 cm				
<input type="checkbox"/> + 1 cm <input type="checkbox"/> + 2 cm	Not available with Rear wheels with brake handles for companion (Drum Brake)		12648	
Mudguard - REMOVABLE				
<i>The distance between the two side guards is 1 cm wider than the seat width</i>				
<input type="radio"/> Removable ABS mudguard			08921	135,00
<input type="radio"/> Removable ABS fibre straight sideguard			08921	135,00
<input type="radio"/> Removable carbon fibre mudguard			08919	466,00
<input type="radio"/> Removable Carbon fibre straight sideguard			08920	466,00

Date	Order	User	Address
------------	-------------	------------	---------------

Armrests





Tubular armrests with standard support combined with anti-tipper wheels exclude the possibility of installing the transit wheels.

<input type="radio"/> Tubular armrests	(Swing away, removable and height adjustable armrest) <input type="radio"/> Standard Support (Not with frame Dynamic) <input type="radio"/> Steel support with safety locking system		04828 189,00 00694 270,00
Removable armrest with integrated mudguard			
<input type="radio"/> Desk armrests PROGEO	(Removable and height adjustable) Not available with Frame Dynamic 2.0 + camber 4°		09956 240,00
Enlargement of Desk armrests PROGEO			
<input checked="" type="checkbox"/> + 0 cm	Available only with Ultra-light Progeo standard wheels and camber 0°		12648
<input type="checkbox"/> + 2 cm			
<input type="radio"/> Flip-up armrests PROGEO	(Removable and height adjustable) Not available with Frame Dynamic 2.0		12277 240,00
<input type="radio"/> Removable armrest with ABS straight sideguard			08881 240,00
<i>The distance between the two side guards is 1 cm wider than the seat width</i>			
<input type="radio"/> Removable armrest with carbon-fiber straight sideguard			08882 486,00
<i>The distance between the two side guards is 1 cm wider than the seat width</i>			



Accessories

<input type="radio"/> Pad for front frame protectors			07058 56,00
<input type="radio"/> Backrest-seat connection cloth			10241 25,00
<input type="radio"/> Removable storage bag (with quick coupling)			09811 135,00

Optional 1

<input type="radio"/> Transit wheels			00836 158,00
<input type="checkbox"/> Anti-tipper with rapid hookup	(inside rotation to reduce the encumbrance) <input type="radio"/> Right <input type="radio"/> Left		00023 145,00 00024 145,00
<input type="radio"/> Tipping aid	<input type="radio"/> Right <input type="radio"/> Left		00025 79,00 01046 79,00
<input type="radio"/> Crutches support	<input type="radio"/> Right <input type="radio"/> Left		00838 79,00 00837 79,00

Optional 2

<input type="radio"/> Tetraclick	(Quick release axle for quadriplegic)		03947 189,00
<input type="radio"/> Rear wheels plate extension	(Not with frame Dynamic 2.0)		01950 189,00
<input type="radio"/> Handybike adaptor			00506 96,00
<input type="radio"/> Push handles for companion	(Removable and height adjustable)		01048 203,00
<input type="radio"/> Harness			04103 145,00
<input type="radio"/> Safety pelvic belt			03972 68,00
<input type="radio"/> Tray table (removable)			00508 294,00
<input type="radio"/> Lumbar support	(to insert in the backrest upholstery)		00013 43,00
<input type="radio"/> Super Head rest	(Folding with the wheelchair)		04049 486,00
<input type="radio"/> Swing away lateral support	<input type="radio"/> Right <input type="radio"/> Left		02097 270,00 02098 270,00
Not available with Posture backrest PHYSIO			
<input type="radio"/> Spoke guards Black	(22"-24")		01043 158,00
<input type="radio"/> Spoke guards Transparent	(22"-24")		00835 158,00
<input type="radio"/> Spoke guards Progeo design	(22"-24")		00019 189,00

Additional Kit

<input type="radio"/> 24" Off-road rear wheels	Off-Road tyre - aluminium handrim (black colour)		03378 534,00
<input type="radio"/> 24" FAT rear wheels	FAT tyre 3" - aluminium handrim (black colour)		09357 895,00

Date Order User Address

Removable with quick release
Suitable for tubes with diameter 18+26mm
Depth adjustment (4cm)
Angle adjustment (±18°)

- AIR** Carbon shell
not available for seat width 48

BACKREST HEIGHT	28	34	40			
Shell's shape 	Lateral retaining wing A=high - R=regular					
	A	R	A	R	A	R
	<input type="checkbox"/>	<input type="checkbox"/>	<input type="checkbox"/>	<input type="checkbox"/>	<input type="checkbox"/>	<input type="checkbox"/>

1.121,00

- POSTURE** Aluminum shell

BACKREST HEIGHT	34	40	52			
Shell's shape 	Lateral retaining wing R=regular					
	R	R	R			
	<input type="checkbox"/>			<input type="checkbox"/>		
				<input type="checkbox"/>		

1.085,00

Alluminum lateral with padded, breathable upholstery.



Small (h 13cm)



- Right 10272
- Left 10272

49,00

Large (h 20cm)



- Right 10273
- Left 10273

49,00

SWING AWAY - Lateral support

Fixing and adjustment hardware complete with protection sleeve
 Alluminum lateral with padded, breathable upholstery.

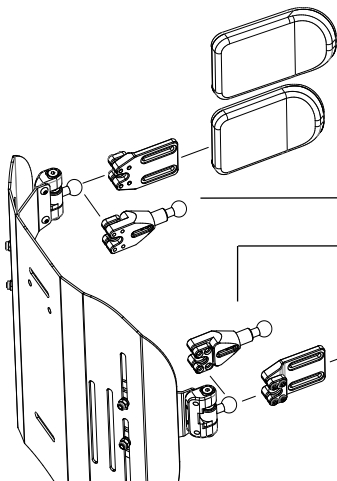

- Large (18x12)
- Small (14x9)
- Lateral support extension
- Lateral support extension
- Small (14x9)
- Large (18x12)

05647 196,00
 05643 196,00
 Quantity (number pcs)..... 10271 74,00
 Quantity (number pcs).....
 05642 196,00
 05646 196,00

- Headrest adjustable - Double ball mounting system
Available only with backrest Physio Posture

- Large (35x12,5)
- Small (25x12,5)



05648 385,00

REFERENCE TABLES

1	Front height	
With closed frame (95°) max 5" caster		
Casters	Front height	
	min.	max
3"	41	52
4"	42	53
5"	44	54
6"	48	55
7"	50	56
The size of the fork will be defined only by Progeo in accordance with wheelchair final configuration.		



2	Rear height				
	Rear frame	Rear wheels			
		22"	24"	25"	26"
STANDARD	Straight plate	min. 37 max 45	min. 39 max 47	min. 40 max 48	min. 41 max 49
	Shaped plate	min. 36 max 49	min. 38 max 51	min. 39 max 52	min. 40 max 53
	Rear wheels plate extension	min. 37 max 46	min. 39 max 48	min. 40 max 50	min. 41 max 51
DYNAMIC 2.0	with Tubular armrests	min. 39 max 46	min. 41 max 48	min. 43 max 50	min. 44 max 51
		min. 36 max 49	min. 38 max 51	min. 39 max 52	min. 40 max 53

3	Footplate option	Frame Angle 110°	Footplate distance Frame Angle 120°	Frame Angle 95°
	Plastic footrest	min. 27	min. 27	min. 27
	One piece footplate - Flip-up!	min. 24	min. 26	min. 24
	One piece footplate - Flip-up! , with multifunction rotative system	min. 19	min. 21	min. 19
	One piece aluminium footplate - Flip-up!	min. 24	min. 26	min. 24
	One piece Carbon fibre footplate	min. 24	min. 26	min. 24
Calculated with the best configuration and with the footplates positioned on inside.				
IMPORTANT NOTICE! From the footplate to the floor minimum 4cm !! (Minimum Front height = DP + 4cm)				

4	Rear wheels	
	Model	Features
	22" Ultra-light Progeo - Standard!	(not available in anthracite color)
	24" Ultra-light Progeo - Standard!	(available for all colours)
	24" ULTRA-LIGHT PROGEO KEY SPORT	(silver hub, black rim and 16 spokes)
	24" Ultra-light "Spinergy LX"	(silver hub, black rim and spokes)
	24" Ultra-light "Spinergy LXL"	(black hub and rim, 18 white spokes) - (black hub, rim and 18 spokes)
	24" Ultra-light "Spinergy Flex rim"	(silver hub, black rim and spokes) - (integrated aluminium/rubber handrim - encumbrance reduction up to 3cm. - all tyre)
	24" Off-road	(colour: black) - (aluminium handrim - tyre Off-road)
	25" Ultra-light "Spinergy LX"	(silver hub, black rim and spokes)
	25" Ultra-light "Spinergy LXL"	(black hub and rim, 18 white spokes)
	26" Progeo - Standard!	(colour: black)
	26" Ultra-light "Spinergy LX"	(silver hub, black rim and 18 spokes)

Date	Order	User	Address
------	-------	------	---------

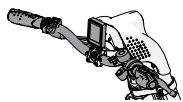
<p>12" wheel - Motor 250W (750W maximum power) 14" wheel - Motor 1000W (1500W maximum power)</p> <p>Color display with switcher Maximum speed limit settable from display 5 speed levels selectable 10 display-selectable acceleration levels Adaptive Cruise Control</p> <p>Disc and electronic brake control lever Motor brake (adjustable in 10 levels from the display) Electronic brake with control bottom (adjustable in 10 levels from the display) Power regain when braking</p> <p>Error messages management from display (with error history) Rear gear beeper 48V - 5.8 Ah battery Autonomy up to 25km 48V - 11.6 Ah Power plus battery Autonomy up to 50km Battery charger 48V</p> <p>Rear gear USB port Easle Mudguard Front spoiler with predisposition for FULL LED light</p> <p style="text-align: center;">(Certified software)</p> <p><input type="radio"/> Mototronik</p>		<p>10979 N/A</p>
---	--	---------------------



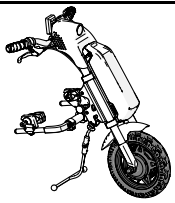

<p>Handlebar</p> <p>☆ STANDARD controls</p> <p> ☆ Thumb accelerator</p> <p> <input type="radio"/> Grip throttle</p> <p> <input type="checkbox"/> Disc and electronic brake control lever</p> <p><input type="radio"/> QUADRIPLEGIC controls Handlebar PUSH&PULL</p>		<p>☆ Right 12592</p> <p>○ Right 10913</p> <p>☆ Right 12594</p>	<p><input type="checkbox"/> Left 12593</p> <p>○ Left 10914</p> <p><input type="checkbox"/> Left 12595</p>	<p></p> <p>42,00</p> <p></p> <p>10905 428,00</p>
--	--	--	---	---

<p>☆ MOTOTRONIK 12" wheel Motor 250W (750W maximum power) Maximum speed according to law</p>		
<p><input type="radio"/> MOTOTRONIK 14" wheel Motor 1000W (1500W maximum power) Maximum speed according to law</p>		<p>10903 428,00</p>

<p>Battery</p>		
<p>☆ 48V - 5.8 Ah battery</p>	<p><i>Autonomy up to 25 km</i></p>	
<p><input type="radio"/> 48V - 11.6 Ah Power plus battery</p>	<p><i>Autonomy up to 50 km</i></p>	<p>10904 289,00</p>

Date Order User Address

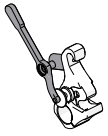
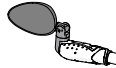
Accessories

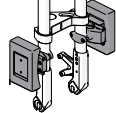
- | | | | | |
|---|---|---|--------|--------|
| <input type="radio"/> FULL LED light (high intensity)
Integrated in the spoiler |  | 10908 | 107,00 | |
| <input type="radio"/> Handlebar extension
Adjustable from 15cm up to 23cm |  | 10907 | 182,00 | |
| <input type="radio"/> Motor unit facilitated unlock lever
Recommended with handlebar for quadriplegic |  | 10915 | 82,00 | |
| <input type="radio"/> Additional FLY 48V - 2.9 Ah battery
Autonomy up to 15km
Approved for air transport | | 10906 | 697,00 | |
| <input type="radio"/> Rearview mirror | <input type="radio"/> Right
<input type="radio"/> Left |  | 10909 | 32,00 |
| | | | 10909 | 32,00 |
| <input type="radio"/> Basket (removable) - (with KLICKfix® attachment system) | |  | 10912 | 212,00 |
| <input type="radio"/> Removable front weight - (with KLICKfix® attachment system)
(it increases the weight over the power wheel to improve traction) | |  | 10910 | 311,00 |
| <input type="radio"/> Travel bag | | | 10916 | 155,00 |

Note

Send this page only if any optional have been chosen

Wheelchair : Progeo EXELLE VARIO - Rev. 2026.0

Prices - VAT excluded
to be added to the price list

- standard (supplied if no requests are indicated)
- on request (without extra charge)
- optional (cost to be added at the basic price)