

permobil Order Form - Progeo noir 2.0

Permobil Limited Unit 7, Polaris Centre, 41 Brownfields, Welwyn Garden City, Herts. AL7 1AN United Kingdom - Phone: +44 1484 722888

Date	UK (English)	
User	Company stamp	Rigid frame wheelchair
End user weight (kg)		£ 8646,00
Language user manual	Responsible	Retail price - VAT not included

Carbon fibre frame made-to-measure.

NOIR is a wheelchair without possibilities of adjustments after its manufacturing..

See reference tables

Take care to write all the requested measures (in centimetres)

Seat depth (PS)

<input type="checkbox"/> 35	<input type="checkbox"/> 37,5
<input type="checkbox"/> 40	<input type="checkbox"/> 42,5
<input type="checkbox"/> 45	<input type="checkbox"/> 47,5

Frame Angle

85° 90° 95°

See note (1)

Backrest rake adjustable from -4° to +16°

Seat width (LS)

<input type="checkbox"/> 33	<input type="checkbox"/> 36
<input type="checkbox"/> 39	<input type="checkbox"/> 42
<input type="checkbox"/> 45	

camber

2° 0° 4°

Front height (min 44-max 54)

Rear height (min 37-max 48)
calculated with rear wheels 24"

Extremely prudential 7,5

Prudential 9

Standard 10,5

Active 12

Extreme 13,5

Footplate option

Carbon fibre frame with integrated footplate, not adjustable
Lightest configuration

Aluminium footplate adjustable distance +/- 1,5cm (rake and depth adjustable)
Minimum footplate distance 35cm.

Internal
 2/3 Internal
 2/3 External
 External

11531

Seat

Seat cloth with pocket (under seat)

Seat with tension straps 08883 **240,00**

Carbon rigid seat 08336 **509,00**

Pocket (under seat) [25x11x4,5] 08281 **79,00**

Date	Order	User	Address
------	-------	------	---------

Backrest adjustment and fixing system

Backrest with double locking (upright and folded) **with rake adjustable from -4° to +16°**
 Backrest with upright locking system ONLY (no locking when folded) **with rake adjustable from -4° to +16°**
 Fixed back(non-folding back) **with rake adjustable from -4° to +16°**

Integrated backrest (Banded, not folding back) 10841 **1.336,00**
 Exclude installation of the titanium backrest
 Exclude installation of the Tubular armrests

(.....) to the ground (.....) to the ground

Backrest

Adjustable velcro straps and padded transpiring upholstery Carbon fibre backrest
 Titanium backrest
Not available with: Integrated backrest (Banded, not folding back)

AIR Integrated posture backrest (NOT REMOVABLE) 1.121,00
 Carbon shell - Lateral retaining 7,5cm
 Depth adjustment ±1cm. - Angle adjustment ±10°
 not available for seat width 48

H 28 Backrest Height (TS) min 34 (.....)	H 34 Backrest Height (TS) min 38 (.....)	H 40 Backrest Height (TS) min 44 (.....)
Lateral retaining wing A=high - R=regular		
A	R	A
<input type="checkbox"/>	<input type="checkbox"/>	<input type="checkbox"/>

Installation on:

Aluminium backrest tubes
 WITHOUT backrest rigidizer
 (Carbon tubes with integrated backrest)
 Carbon fibre backrest
 Titanium backrest
 Not available with: Integrated backrest (Banded, not folding back)

Handle tube

Tubes with short handle
 SPORT tubes Without push handles *Lightest configuration*
 Folding handles **Minimum backrest height 30,5cm**

13598 **270,00**

Casters

3" Sport *Lightest configuration*
 4" Soft
 3" Active Soft (wide) (Aluminium alloy rim)
 4" Active Sport (narrow) (Aluminium alloy rim)
 4" Active Soft (wide) (Aluminium alloy rim)
 5" Active Soft (wide) (Aluminium alloy rim)
 5" Pneumatic

Rear wheels - See chart N°3

24" ULTRA-LIGHT PROGEO KEY SPORT *Lightest configuration*
 24" Ultra-light "Spinergy LX"
 24" Ultra-light "Spinergy LXL"
 24" Ultra-light "Spinergy Flex rim" Black hub and white spokes Hub and spokes black
 25" Ultra-light "Spinergy LX" Integrated aluminium/rubber handrim
 25" Ultra-light "Spinergy LXL" Black hub and white spokes
 26" Ultra-light "Spinergy LX"

04353 **1.150,00**

Permobil Limited Unit 7, Polaris Centre, 41 Brownfields, Welwyn Garden City, Herts, AL7 1AN United Kingdom - Phone: +44 1484 722888

customer_support_uk@permobil.com - https://www.permobil.com/en-gb

Date	Order	User	Address
------------	-------------	------------	---------------

Rear wheel tyre				
<input checked="" type="checkbox"/> High pressure tyre	(24"-25"-26")	<i>Lightest configuration</i>		
<input type="checkbox"/> High pressure profile tyre	(24")			
<input type="checkbox"/> Marathon Plus	(24"-25")	with anti-puncture protection	01669	95,00
<input type="checkbox"/> Anti-puncture - Colour Black	(24")		11083	95,00
Not available with Rear wheels : 24" ULTRA-LIGHT PROGEO KEY SPORT, 24" Ultra-light "Spinergy LXL"				

Handrim		Wheel distance <input checked="" type="checkbox"/> 3 cm <input type="checkbox"/> 4 cm		
<input checked="" type="checkbox"/> Aluminium	(24"-25"-26")	<i>Lightest configuration</i>		
<input type="checkbox"/> Aluminium black SOFT-TOUCH	(24"-25")	(24" handrim, on 25" wheel is installed with spacers)	09170	160,00
<input type="checkbox"/> Chromed Steel	(24"-25")	(24" handrim, on 25" wheel is installed with spacers)	01684	160,00
<input type="checkbox"/> Titanium	(24"-25")	(24" handrim, on 25" wheel is installed with spacers)	13591	290,00
<input type="checkbox"/> Ultra Grepp	(24"-25")	(24" handrim, on 25" wheel is installed with spacers)	00017	290,00
<input type="checkbox"/> TOP FRICTION	(24"-25")	(24" handrim, on 25" wheel is installed with spacers)	11023	290,00
<i>Oval countour with a rubber insert</i>				
<input type="checkbox"/> NOVA H	(24"-25")	(24" handrim, on 25" wheel is installed with spacers)	11025	290,00
<i>Ergonomic black profile</i>				
<input type="checkbox"/> NOVA D	(24"-25")	(24" handrim, on 25" wheel is installed with spacers)	11026	290,00
<i>Ergonomic profile with rubber coating (ideal for quadriplegics)</i>				
<input type="checkbox"/> Silicon cover for standard aluminium handrim	Available for measures (22" - 24" - 26")		04050	172,00

Wheel locks		
<input checked="" type="checkbox"/> Sport brake		
<input type="checkbox"/> Bent lever push to lock		
<input type="checkbox"/> Straight lever push to lock		
<input type="checkbox"/> Straight lever pull to lock		
<input type="checkbox"/> Brake with extension lever push to lock		
<input type="checkbox"/> Brake with extension lever pull to lock		

Mudguard				
<input checked="" type="checkbox"/> Carbon fibre mudguard				
<input type="checkbox"/> Carbon fibre Straight sideguard	<input checked="" type="checkbox"/> Aligned wheel	<input type="checkbox"/> Under wheel cm	<input type="checkbox"/> Above wheel cm	
<input type="checkbox"/> Mudguard enlargement				
<input checked="" type="checkbox"/> + 0 cm	<input type="checkbox"/> + 1 cm	<input type="checkbox"/> + 2 cm		12648
<input type="checkbox"/> Removable carbon fibre mudguard				04109 270,00
<input type="checkbox"/> Removable Carbon fibre straight sideguard	<input checked="" type="checkbox"/> Aligned wheel	<input type="checkbox"/> Under wheel cm	<input type="checkbox"/> Above wheel cm	04109 270,00

Armrests		
<input type="checkbox"/> Tubular armrests	(Swing away, removable and height adjustable armrest)	
Not available with Integrated backrest (Banded, not folding back)		
		00694 270,00

Accessories		
<input type="checkbox"/> Pad for front frame protectors		07058 56,00
<input type="checkbox"/> Backrest-seat connection cloth		10241 25,00
<input type="checkbox"/> Removable storage bag (with quick coupling)		09811 135,00

Optional 1		
<input type="checkbox"/> Transit wheels		03290 158,00
<input type="checkbox"/> Anti-tipper with rapid hookup	(inside rotation to reduce the encumbrance)	
	<input type="checkbox"/> Right	06821 145,00
	<input type="checkbox"/> Left	06822 145,00

Optional 2		
<input type="checkbox"/> Safety pelvic belt		03972 68,00
<input type="checkbox"/> Harness		04103 145,00
<input type="checkbox"/> Lumbar support	(to insert in the backrest upholstery)	00013 43,00
<input type="checkbox"/> Tetraclip	(Quick release axle for quadriplegic)	03947 189,00

Additional Kit		
<input type="checkbox"/> 24" Off-road rear wheels	Off-Road tyre - aluminium handrim (black colour)	03378 534,00
<input type="checkbox"/> 24" FAT rear wheels	FAT tyre 3" - aluminium handrim (black colour)	09357 895,00

Date Order User Address

PHYSIO - Posture backrest (Std. Backrest upholstery not provided)

Removable with quick release
Suitable for tubes with diameter 18÷26mm
Depth adjustment (4cm)
Angle adjustment (±18°)

- AIR** Carbon shell
not available for seat width 48

BACKREST HEIGHT	28	34	40			
Shell's shape 	Lateral retaining wing A=high - R=regular					
	A	R	A	R	A	R

1.121,00

- POSTURE** Aluminum shell

BACKREST HEIGHT	34	40	52			
Shell's shape 	Lateral retaining wing R=regular					
	R	R	R			

1.085,00

Configuration DEEP with side support PAD (height adjustable)

Alluminum lateral with padded, breathable upholstery.



Small (h 13cm)



Right
10272

49,00

Left
10272

49,00

Large (h 20cm)



Right
10273

49,00

Left
10273

49,00

SWING AWAY - Lateral support

Fixing and adjustment hardware complete with protection sleeve
Alluminum lateral with padded, breathable upholstery.

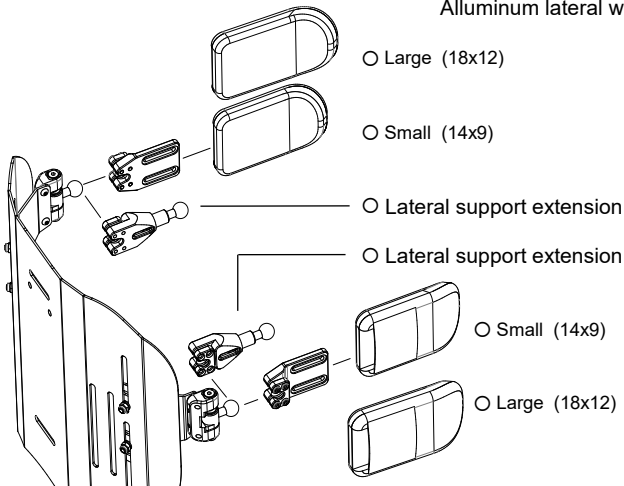

Large (18x12)

05647

196,00

Small (14x9)

05643

196,00

Lateral support extension

Quantity (number pcs).....

10271

74,00

Lateral support extension

Quantity (number pcs).....

Small (14x9)

05642

196,00

Large (18x12)

05646

196,00

- Headrest adjustable - Double ball mounting system
Available only with backrest Physio Posture



Large (35x12,5)
 Small (25x12,5)

05648

385,00

Date	Order	User	Address
------------	-------------	------------	---------------

REFERENCE TABLES

Progeo (Español) NOIR is a wheelchair without possibilities of adjustments after its manufacturing.

(1) The real seat depth, from the front part of the seat cloth to the backrest tube will be 1,5 cm more than the declared one.

1	A Footplate width		
DP \ LS	35÷39	40÷45	46÷50
33	21,5	21	20,5
36	24,5	24	23,5
39	27,5	27	26,5
42	30,5	30	29,5
45	33,5	33	32,5
48	36,5	36	35,5

2	Setting	C :
	Extremely prudential	7,5
	Prudential	9
	Standard	10,5
	Active	12
	Extreme	13,5



3	Maximum width
Camber	
0°	LS + 18
2°	LS + 21
4°	LS + 24

Maximum width calculated including 3 cm. distance between tyre and handrim

Wheelchair : Progeo noir 2.0 - Rev. 2026.0	Prices - VAT excluded to be added to the price list	Send this page only if any optional have been chosen <input checked="" type="checkbox"/> standard (supplied if no requests are indicated) <input type="checkbox"/> on request (without extra charge) <input type="checkbox"/> optional (cost to be added at the basic price)
--	--	---

Date	Order	User	Address
------	-------	------	---------

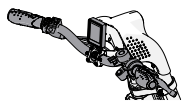
<p>12" wheel - Motor 250W (750W maximum power) 14" wheel - Motor 1000W (1500W maximum power)</p> <p>Color display with switcher Maximum speed limit settable from display 5 speed levels selectable 10 display-selectable acceleration levels Adaptive Cruise Control</p> <p>Disc and electronic brake control lever Motor brake (adjustable in 10 levels from the display) Electronic brake with control bottom (adjustable in 10 levels from the display) Power regain when braking</p> <p>Error messages management from display (with error history) Rear gear beeper 48V - 5.8 Ah battery Autonomy up to 25km 48V - 11.6 Ah Power plus battery Autonomy up to 50km Battery charger 48V</p> <p>Rear gear USB port Easle Mudguard Front spoiler with predisposition for FULL LED light</p> <p style="text-align: center;">(Certified software)</p> <p><input type="radio"/> Mototronik</p>	
<p>10979 N/A</p>	





Handlebar			
<p>☆ STANDARD controls</p> <p> ☆ Thumb accelerator</p> <p> <input type="radio"/> Grip throttle</p> <p> <input type="checkbox"/> Disc and electronic brake control lever</p>	<p> ☆ Right 12592</p> <p> <input type="radio"/> Right 10913</p> <p> ☆ Right 12594</p>	<p> <input type="checkbox"/> Left 12593</p> <p> <input type="radio"/> Left 10914</p> <p> <input type="checkbox"/> Left 12595</p>	 <p>42,00</p>  <p>10905 428,00</p>
<p><input type="radio"/> QUADRIPLEGIC controls Handlebar PUSH&PULL</p>			

<p>☆ MOTOTRONIK 12" wheel Motor 250W (750W maximum power) Maximum speed according to law</p>	
<p><input type="radio"/> MOTOTRONIK 14" wheel Motor 1000W (1500W maximum power) Maximum speed according to law</p>	
	<p>10903 428,00</p>

Battery		
<p>☆ 48V - 5.8 Ah battery</p> <p><input type="radio"/> 48V - 11.6 Ah Power plus battery</p>	<p><i>Autonomy up to 25 km</i></p> <p><i>Autonomy up to 50 km</i></p>	<p>10904 289,00</p>

Date Order User Address

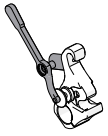
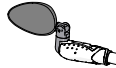
Accessories

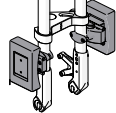
- | | | | | |
|---|---|---|--------|-------|
| <input type="radio"/> FULL LED light (high intensity)
Integrated in the spoiler |  | 10908 | 107,00 | |
| <input type="radio"/> Handlebar extension
Adjustable from 15cm up to 23cm |  | 10907 | 182,00 | |
| <input type="radio"/> Motor unit facilitated unlock lever
Recommended with handlebar for quadriplegic |  | 10915 | 82,00 | |
| <input type="radio"/> Additional FLY 48V - 2.9 Ah battery
Autonomy up to 15km
Approved for air transport | | 10906 | 697,00 | |
| <input type="radio"/> Rearview mirror | <input type="radio"/> Right
<input type="radio"/> Left |  | 10909 | 32,00 |
| | | 10909 | 32,00 | |
| <input type="radio"/> Basket (removable) - (with KLICKfix® attachment system) |  | 10912 | 212,00 | |
| <input type="radio"/> Removable front weight - (with KLICKfix® attachment system)
(it increases the weight over the power wheel to improve traction) |  | 10910 | 311,00 | |
| <input type="radio"/> Travel bag | | 10916 | 155,00 | |

Note

Send this page only if any optional have been chosen

- | | | |
|---|------------|---|
| ☆ | standard | (supplied if no requests are indicated) |
| □ | on request | (without extra charge) |
| ○ | optional | (cost to be added at the basic price) |