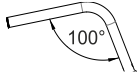
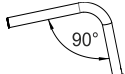
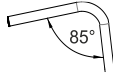

Permobil Limited Unit 7, Polaris Centre, 41 Brownfields, Welwyn Garden City, Herts, AL7 1AN United Kingdom - Phone: +44 1484 722888

Date	UK (English)	
User	Company stamp	Folding frame wheelchair
End user weight (kg)		£ 3950,00
Language user manual	Responsible	Retail price - VAT not included

Wheelchair measures - The tolerance on all the dimensions indicated and/or required is ± 10 mm						
Seat width (LS)	<input type="checkbox"/> 33	<input type="checkbox"/> 36	<input type="checkbox"/> 39	<input type="checkbox"/> 42	<input type="checkbox"/> 45	<input type="checkbox"/> 48
The seat width is measured from the outer sides of the frame, while the distance between the two side guards is 1 cm wider. For seat enlargement see section enlargement of mudguard and armrest with integrated mudguard						
Seat depth (PS)	<input type="checkbox"/> 35	<input type="checkbox"/> 37,5	<input type="checkbox"/> 40	<input type="checkbox"/> 42,5	<input type="checkbox"/> 45	<input type="checkbox"/> 47,5
The real seat depth, from the front part of the seat cloth to the backrest tube will be 1,5 cm more than the declared one.						
Footplate distance (DP) (cm) ±0.5cm - adjustment steps 1.5cm (Real distance between seat and footplate) - IMPORTANT NOTICE! From the footplate to the floor minimum 4cm !! (Minimum Front height = DP + 4cm)					
Setting	<input checked="" type="checkbox"/> Standard		<input type="checkbox"/> Prudential		<input type="checkbox"/> Active	
Backrest Height (TS)	Std. Value 33,5(min 26-max 47) adjustment steps 1.5cm					
camber	<input checked="" type="checkbox"/> 0°		<input type="checkbox"/> 2°			
Front height STD 49					
Rear height STD 42					

Front frame		
<input checked="" type="checkbox"/> Aluminium standard frame		
 <input checked="" type="checkbox"/>	 <input type="checkbox"/>	 <input type="checkbox"/>
(max 5" caster)		(max 4" caster)

Frame colour		
Frame colour (without extra charge)		
<input checked="" type="checkbox"/> Opaque black	<input type="checkbox"/> POLAR white	<input type="checkbox"/> Matt orange
<input type="checkbox"/> Tekno anthracite	<input type="checkbox"/> Matt Midnight blue	<input type="checkbox"/> Matt grey
Frame colour on request		
<input type="checkbox"/> Bright silver	<input type="checkbox"/> Bright fuchsia	<input type="checkbox"/> Bright blue china
<input type="checkbox"/> Bright blue	<input type="checkbox"/> Bright lime	<input type="checkbox"/> Bright red
	12579	109,00

Backrest
<input checked="" type="checkbox"/> Adjustable velcro straps and padded transpiring upholstery

Handle tube	
<input checked="" type="checkbox"/> Tubes with short handle	
<input type="checkbox"/> Tubes with standard handle	
<input type="checkbox"/> SPORT tubes Without push handles	<i>Lightest configuration</i>
<input type="checkbox"/> Folding handles	
Not available with: Push handles for companion	02958 270,00

Casters		
<input checked="" type="checkbox"/> 4" Soft		
<input type="checkbox"/> 3" Sport	<i>Lightest configuration</i>	
<input type="checkbox"/> 5" Soft		
<input type="checkbox"/> 6" Soft	(Available only with 100° angle)	
<input type="checkbox"/> 6" Pneumatic	(Available only with 100° angle)	
<input type="checkbox"/> 3" Active Soft (wide)	(Aluminium alloy rim)	06824 95,00
<input type="checkbox"/> 4" Active Sport (narrow)	(Aluminium alloy rim)	01398 95,00
<input type="checkbox"/> 4" Active Soft (wide)	(Aluminium alloy rim)	03943 95,00
<input type="checkbox"/> 5" Active Soft (wide)	(Aluminium alloy rim)	07518 95,00
<input type="checkbox"/> 5" Pneumatic		10844 68,00

Support front fork	
<input checked="" type="checkbox"/> Standard support front fork	
<input type="checkbox"/> Front fork support V Design 2.0	
Exclude the installation of : Quick release front forks	

customer_support_uk@permobil.com - https://www.permobil.com/en-gb

Date	Order	User	Address
------------	-------------	------------	---------------

Special Options		
<input type="radio"/> Rear wheels plate extension	01950	189,00
<input type="radio"/> lockingband/strip to close/fold the wheelchair	06833	25,00
<input type="radio"/> Drawstring to unlock the back with a singleaction	06834	135,00

Colour set: includes rear wheel hub and rim and front forks		
Only standard Progeo 22"/24" wheels have coloured hubs and rims		
☆ Black	22" 24" 25" 26"	
<input type="radio"/> Bright silver	22" 24"	00833 135,00
<input type="radio"/> Bright lime	22" 24"	00833 135,00
<input type="radio"/> Bright blue	22" 24"	00833 135,00
<input type="radio"/> Bright red	22" 24"	00833 135,00
<input type="radio"/> Bright fuchsia	22" 24"	00833 135,00
<input type="radio"/> POLAR white	22" 24"	00833 135,00
<input type="radio"/> Tekno anthracite	22" 24"	00833 135,00
<input type="radio"/> Matt Midnight blue	22" 24"	00833 135,00
<input type="radio"/> Matt grey	22" 24"	00833 135,00
<input type="radio"/> Matt red	22" 24"	00833 135,00

Rear wheels		
☆ 24" Ultra-light Progeo - Standard!		
<input type="checkbox"/> 22" Ultra-light Progeo - Standard!		
<input type="checkbox"/> 25" Ultra-light Progeo - Standard!	(colour: black)	
<input type="checkbox"/> 26" Progeo - Standard!	(colour: black)	
<input type="radio"/> 24" ULTRA-LIGHT PROGEO KEY SPORT	<i>Lightest configuration</i>	04383 695,00
<input type="radio"/> 24" Ultra-light "Spinergy LX"		01685 695,00
<input type="radio"/> 24" Ultra-light "Spinergy LXL"	<input type="checkbox"/> Black hub and white spokes <input type="checkbox"/> Hub and spokes black	07846 695,00
<input type="radio"/> 24" Ultra-light "Spinergy Flex rim"	Integrated aluminium/rubber handrim	02270 1.150,00
<input type="radio"/> 25" Ultra-light "Spinergy LX"		02101 695,00
<input type="radio"/> 25" Ultra-light "Spinergy LXL"	<input type="checkbox"/> Black hub and white spokes	07847 695,00
<input type="radio"/> 26" Ultra-light "Spinergy LX"		02102 695,00
<input type="radio"/> 24" Off-road (aluminium handrim black - Wheel distance 4cm)		01392 270,00

Rear wheel tyre		
☆ High pressure tyre	(22"-24"-25"-26")	<i>Lightest configuration</i>
<input type="checkbox"/> High pressure profile tyre	(24")	
<input type="radio"/> Marathon Plus	(24"-25")	with anti-puncture protection
<input type="radio"/> Anti-puncture - Colour Black	(24")	01669 95,00
Not available with Rear wheels : 24" ULTRA-LIGHT PROGEO KEY SPORT, 24" Ultra-light "Spinergy LXL"		
<input type="radio"/> Anti-puncture - Colour Grey	(22")	04181 105,00

Handrim	Wheel distance	☆ 3 cm	□ 4 cm		
☆ Aluminium	(22"-24"-25"-26")	<i>Lightest configuration</i>			
<input type="radio"/> Aluminium black SOFT-TOUCH	(24"-25")	(24" handrim, on 25" wheel is installed with spacers)		09170	160,00
<input type="radio"/> Chromed Steel	(24"-25")	(24" handrim, on 25" wheel is installed with spacers)		01684	160,00
<input type="radio"/> Titanium	(24"-25")	(24" handrim, on 25" wheel is installed with spacers)		00016	290,00
<input type="radio"/> Ultra Grepp	(24"-25")	(24" handrim, on 25" wheel is installed with spacers)		00017	290,00
<input type="radio"/> TOP FRICTION	(24"-25")	(24" handrim, on 25" wheel is installed with spacers)		11023	290,00
Oval countour with a rubber insert					
<input type="radio"/> NOVA H	(24"-25")	(24" handrim, on 25" wheel is installed with spacers)		11025	290,00
Ergonomic black profile					
<input type="radio"/> NOVA D	(24"-25")	(24" handrim, on 25" wheel is installed with spacers)		11026	290,00
Ergonomic profile with rubber coating (ideal for quadriplegics)					
<input type="radio"/> Silicon cover for standard aluminium handrim		Available for measures (22"- 24" - 26")		04050	172,00

Wheel locks		
☆ Bent lever push to lock		
<input type="checkbox"/> Straight lever push to lock		
<input type="checkbox"/> Straight lever pull to lock		
<input type="radio"/> Sport brake	<i>Lightest configuration</i>	06428 135,00
<input type="radio"/> Brake with extension lever push to lock		01949 68,00
<input type="radio"/> Brake with extension lever pull to lock		03372 68,00



Date Order User Address

Automatic Closure footplate

☆ Footplate COMPACT, automatic Closure

Lightest configuration



11529

Minimum footplate distance 35cm.

Internal External

RAKE AND DEPTH ADJUSTABLE

Footplate - See reference tables N°3

Warning!! All flip-up footrests, need a stretch calf band and standard fork-support

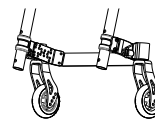

Weight increase approx. 500gr.

Plastic footrest. rake adjustable

Minimum footplate distance 35cm.

☆ 2/3 Internal 2/3 External



11525

One piece footplate - Flip-up!. rake and depth adjustable

Minimum footplate distance 35cm.

Internal ☆ 2/3 Internal External

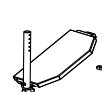

11527

One piece aluminium footplate - Flip-up!. rake and depth adjustable

Minimum footplate distance 35cm.

Internal ☆ 2/3 Internal 2/3 External



11528

One piece Carbon fibre footplate, rake adjustable, swing away, flip-up.

Minimum footplate distance 35cm.

☆ Internal External



03291

294,00

Mudguard

Mudguard - FIXED

☆ Carbon fibre mudguard

Carbon fibre Straight sideguard

Mudguard enlargement

☆ + 0 cm

+ 1 cm

+ 2 cm

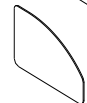
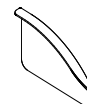

12648

Extra charge for : REMOVABLE VERSION

NO → Mudguard enlargement



08921

135,00

Armrests

Tubular armrests

(Swing away, removable and height adjustable armrest)



00694

270,00

Removable armrest with integrated mudguard

Desk armrests PROGEO

(Removable and height adjustable)



09956

240,00

Enlargement of Desk armrests PROGEO

☆ + 0 cm

+ 2 cm

Available only with Ultra-light Progeo standard wheels and camber 0°

12648

Removable armrest with carbon-fiber straight sideguard



09079

240,00

Accessories

Pad for front frame protectors

07058

56,00

Backrest-seat connection cloth

10241

25,00

Removable storage bag (with quick coupling)





09811



135,00

Permobil Limited Unit 7, Polaris Centre, 41 Brownfields, Welwyn Garden City, Herts, AL7 1AN United Kingdom - Phone: +44 1484 722888

customer_support_uk@permobil.com - https://www.permobil.com/en-gb

Date	Order	User	Address
------------	-------------	------------	---------------

Optional 1				
<input type="radio"/> Transit wheels			00836	158,00
<input type="radio"/> Anti-tipper with rapid hookup	(inside rotation to reduce the encumbrance)		00023	145,00
	<input type="radio"/> Right		00024	145,00
	<input type="radio"/> Left			
<input type="radio"/> Tipping aid	<input type="radio"/> Right		00025	79,00
	<input type="radio"/> Left		01046	79,00
<input type="radio"/> Crutches support	<input type="radio"/> Right		00838	79,00
	<input type="radio"/> Left		00837	79,00

Optional 2				
<input type="radio"/> Tetraclip	(Quick release axle for quadriplegic)		03947	189,00
<input type="radio"/> Safety pelvic belt			03972	68,00
<input type="radio"/> Harness			04103	145,00
<input type="radio"/> Quick release front forks	Available with: Standard support front fork		00030	158,00
<input type="radio"/> Push handles for companion	(Removable and height adjustable)		01048	203,00
<input type="radio"/> Lumbar support	(to insert in the backrest upholstery)		00013	43,00
<input type="radio"/> Swing away lateral support	Not available with Posture backrest PHYSIO		02097	270,00
Prevents backrest folding	<input type="radio"/> Right		02098	270,00
	<input type="radio"/> Left			
<input type="radio"/> Spoke guards Black	(22"-24")		01043	158,00
<input type="radio"/> Spoke guards Transparent	(22"-24")		00835	158,00
<input type="radio"/> Spoke guards Progeo design	(22"-24")		00019	189,00





Additional Kit				
<input type="radio"/> 24" Off-road rear wheels	Off-Road tyre - aluminium handrim (black colour)		03378	534,00
<input type="radio"/> 24" FAT rear wheels	FAT tyre 3" - aluminium handrim (black colour)		09357	895,00

Date Order User Address

PHYSIO - Posture backrest (Std. Backrest upholstery not provided)

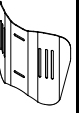
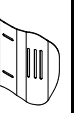

Removable with quick release
Suitable for tubes with diameter 18+26mm
Depth adjustment (4cm)
Angle adjustment (±18°)

- AIR** Carbon shell
not available for seat width 48

BACKREST HEIGHT	28	34	40			
Shell's shape 	Lateral retaining wing A=high - R=regular					
	A	R	A	R	A	R
						
	<input type="checkbox"/>	<input type="checkbox"/>	<input type="checkbox"/>	<input type="checkbox"/>	<input type="checkbox"/>	<input type="checkbox"/>

1.121,00

- POSTURE** Aluminum shell

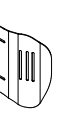
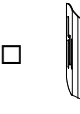
BACKREST HEIGHT	34	40	52			
Shell's shape 	Lateral retaining wing R=regular					
	R	R	R			
						
	<input type="checkbox"/>	<input type="checkbox"/>	<input type="checkbox"/>			

1.085,00

Configuration DEEP with side support PAD (height adjustable)

Alluminum lateral with padded, breathable upholstery.



Small (h 13cm)



- Right 10272

49,00

- Left 10272

49,00

Large (h 20cm)



- Right 10273

49,00

- Left 10273

49,00

SWING AWAY - Lateral support

Fixing and adjustment hardware complete with protection sleeve
Alluminum lateral with padded, breathable upholstery.

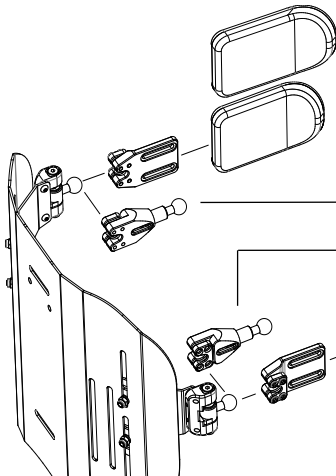

- Large (18x12)

05647 196,00

- Small (14x9)

05643 196,00

- Lateral support extension

Quantity (number pcs).....

10271 74,00

- Lateral support extension

Quantity (number pcs).....

- Small (14x9)

05642 196,00

- Large (18x12)

05646 196,00

- Headrest adjustable - Double ball mounting system

Available only with backrest Physio Posture



- Large (35x12,5)

05648 385,00

- Small (25x12,5)

Permobil Limited Unit 7, Polaris Centre, 41 Brownfields, Welwyn Garden City, Herts, AL7 1AN United Kingdom - Phone: +44 1484 722888



customer_support_uk@permobil.com - https://www.permobil.com/en-gb

Date	Order	User	Address
------------	-------------	------------	---------------

Note

Wheelchair : Progeo EGO - Rev. 2026.0	Prices - VAT excluded <small>to be added to the price list</small>	<table border="1" style="width: 100%; border-collapse: collapse;"> <tr> <td colspan="2" style="text-align: center; padding: 2px;">Send this page only if any optional have been chosen</td> </tr> <tr> <td style="padding: 2px;"><input checked="" type="checkbox"/> standard</td> <td style="padding: 2px;"><small>(supplied if no requests are indicated)</small></td> </tr> <tr> <td style="padding: 2px;"><input type="checkbox"/> on request</td> <td style="padding: 2px;"><small>(without extra charge)</small></td> </tr> <tr> <td style="padding: 2px;"><input type="checkbox"/> optional</td> <td style="padding: 2px;"><small>(cost to be added at the basic price)</small></td> </tr> </table>	Send this page only if any optional have been chosen		<input checked="" type="checkbox"/> standard	<small>(supplied if no requests are indicated)</small>	<input type="checkbox"/> on request	<small>(without extra charge)</small>	<input type="checkbox"/> optional	<small>(cost to be added at the basic price)</small>
Send this page only if any optional have been chosen										
<input checked="" type="checkbox"/> standard	<small>(supplied if no requests are indicated)</small>									
<input type="checkbox"/> on request	<small>(without extra charge)</small>									
<input type="checkbox"/> optional	<small>(cost to be added at the basic price)</small>									

REFERENCE TABLES

1		Front height			
		With closed frame (95°) max 5" caster			
		With closed frame (90°) max 5" caster			
		With closed frame (85°) max 4" caster			
FORK		Casters			
		3"	4"	5"	6"
SMALL 		max 46	max 47	max 48	
MEDIUM 		max 50	max 51	max 52	max 54
The size of the fork will be defined only by Progeo in accordance with wheelchair final configuration.					



2		Rear height			
		Rear wheels			
		22"	24"	25"	26"
min		min	min	min	min
35		38	39	40	40
max		max	max	max	max
43		45	46	46	48

3	Footplate option	Footplate distance
	Footplate COMPACT, automatic Closure	min 36
	Plastic footrest	min 36
	One piece footplate - Flip-up!	min 36
	One piece aluminium footplate - Flip-up!	min 36
	One piece Carbon fibre footplate	min 36
IMPORTANT NOTICE! From the footplate to the floor minimum 4cm !! (Minimum Front height = DP + 4cm)		
NOTE! Lower footplate distances are possible only after our valuation		
Calculated with the best configuration and with the footplates positioned on inside.		

4	Rear wheels	
	Model	Features
	22" Ultra-light Progeo - Standard!	(not available in anthracite color)
	24" Ultra-light Progeo - Standard!	(available for all coulores)
	24" ULTRA-LIGHT PROGEO KEY SPORT	(silver hub, black rim and 16 spokes)
	24" Ultra-light "Spinergy LX"	(silver hub, black rim and spokes)
	24" Ultra-light "Spinergy LXL"	(black hub and rim, 18 white spokes) - (black hub, rim and 18 spokes)
	24" Ultra-light "Spinergy Flex rim"	(silver hub, black rim and spokes) - (integrated aluminium/rubber handrim - encumbrance reduction up to 3cm. - all tyre)
	24" Off-road	(colour: black) - (aluminium handrim - tyre Off-road)
	25" Ultra-light "Spinergy LX"	(silver hub, black rim and spokes)
	25" Ultra-light "Spinergy LXL"	(black hub and rim, 18 white spokes)
	26" Progeo - Standard!	(colour: black)
	26" Ultra-light "Spinergy LX"	(silver hub, black rim and 18 spokes)

Date	Order	User	Address
------	-------	------	---------

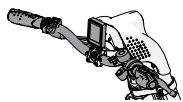
<p>12" wheel - Motor 250W (750W maximum power) 14" wheel - Motor 1000W (1500W maximum power)</p> <p>Color display with switcher Maximum speed limit settable from display 5 speed levels selectable 10 display-selectable acceleration levels Adaptive Cruise Control</p> <p>Disc and electronic brake control lever Motor brake (adjustable in 10 levels from the display) Electronic brake with control bottom (adjustable in 10 levels from the display) Power regain when braking</p> <p>Error messages management from display (with error history) Rear gear beeper 48V - 5.8 Ah battery Autonomy up to 25km 48V - 11.6 Ah Power plus battery Autonomy up to 50km Battery charger 48V</p> <p>Rear gear USB port Easle Mudguard Front spoiler with predisposition for FULL LED light</p> <p style="text-align: center;">(Certified software)</p> <p><input type="radio"/> Mototronik</p>		<p>10979 N/A</p>
-----------------------------------------------------------------------------------------------------------------------------------------------------------------------------------------------------------------------------------------------------------------------------------------------------------------------------------------------------------------------------------------------------------------------------------------------------------------------------------------------------------------------------------------------------------------------------------------------------------------------------------------------------------------------------------------------------------------------------------------------------------------------------------------------------------------------------------------------------------------------------------------------------------------------------------------------------------------------------	------------------------------------------------------------------------------------	---------------------



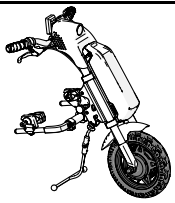

<p>Handlebar</p> <p>☆ STANDARD controls</p> <p> ☆ Thumb accelerator</p> <p> <input type="radio"/> Grip throttle</p> <p> <input type="checkbox"/> Disc and electronic brake control lever</p>		<p>☆ Right 12592</p> <p>○ Right 10913</p> <p>☆ Right 12594</p>	<p><input type="checkbox"/> Left 12593</p> <p>○ Left 10914</p> <p><input type="checkbox"/> Left 12595</p>	<p></p> <p>42,00</p>
<p><input type="radio"/> QUADRIPLEGIC controls Handlebar PUSH&PULL</p>				<p></p> <p>10905 428,00</p>

<p>☆ MOTOTRONIK 12" wheel Motor 250W (750W maximum power) Maximum speed according to law</p>		
<p><input type="radio"/> MOTOTRONIK 14" wheel Motor 1000W (1500W maximum power) Maximum speed according to law</p>		<p>10903 428,00</p>

<p>Battery</p>		
<p>☆ 48V - 5.8 Ah battery</p> <p>○ 48V - 11.6 Ah Power plus battery</p>	<p><i>Autonomy up to 25 km</i></p> <p><i>Autonomy up to 50 km</i></p>	<p>10904 289,00</p>

Date Order User Address

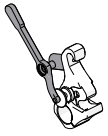
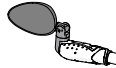
Accessories

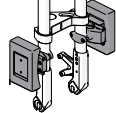
- | | | | | |
|---------------------------------------------------------------------------------------------------------------------------------------------------------|-------------------------------------------------------------------------------------|---------------------------------------------------------------------------------------|--------|--------|
| <input type="radio"/> FULL LED light (high intensity)
Integrated in the spoiler |  | 10908 | 107,00 | |
| <input type="radio"/> Handlebar extension
Adjustable from 15cm up to 23cm |  | 10907 | 182,00 | |
| <input type="radio"/> Motor unit facilitated unlock lever
Recommended with handlebar for quadriplegic |  | 10915 | 82,00 | |
| <input type="radio"/> Additional FLY 48V - 2.9 Ah battery
Autonomy up to 15km
Approved for air transport | | 10906 | 697,00 | |
| <input type="radio"/> Rearview mirror | <input type="radio"/> Right
<input type="radio"/> Left |  | 10909 | 32,00 |
| | | | 10909 | 32,00 |
| <input type="radio"/> Basket (removable) - (with KLICKfix® attachment system) | |  | 10912 | 212,00 |
| <input type="radio"/> Removable front weight - (with KLICKfix® attachment system)
(it increases the weight over the power wheel to improve traction) | |  | 10910 | 311,00 |
| <input type="radio"/> Travel bag | | | 10916 | 155,00 |

Note

Send this page only if any optional have been chosen

- | | | |
|-------------------------------------|------------|-----------------------------------------|
| <input checked="" type="checkbox"/> | standard | (supplied if no requests are indicated) |
| <input type="checkbox"/> | on request | (without extra charge) |
| <input type="radio"/> | optional | (cost to be added at the basic price) |