



Date	UK (English)	
User	Company stamp	Folding frame wheelchair
End user weight (kg)		£ 1900,00
Language user manual	Responsible	Retail price - VAT not included

Wheelchair measures - The tolerance on all the dimensions indicated and/or required is ± 10 mm	
Seat width (LS) <input type="checkbox"/> 33 <input type="checkbox"/> 36 <input type="checkbox"/> 39 <input type="checkbox"/> 42 <input type="checkbox"/> 45 <input type="checkbox"/> 48	
The seat width is measured from the outer sides of the frame	
For seat enlargement see section enlargement of mudguard and armrest with integrated mudguard	
Seat depth (PS) <input type="checkbox"/> 35 <input type="checkbox"/> 37,5 <input type="checkbox"/> 40 <input type="checkbox"/> 42,5 <input type="checkbox"/> 45 <input type="checkbox"/> 47,5 <input checked="" type="checkbox"/> 50	
Footplate distance (DP) (cm) ±0.5cm - adjustment steps 1.5cm	
(Real distance between seat and footplate) - IMPORTANT NOTICE! From the footplate to the floor minimum 4cm !! (Minimum Front height = DP + 4cm)	
Setting ☆ Standard <input type="checkbox"/> Prudential <input type="checkbox"/> Active <input type="checkbox"/> Extreme	
Backrest Height (TS) Std. Value 36(min 30-max 54) adjustment steps 1.5cm	
Crossbrace (black) ☆ Single <input type="checkbox"/> Double (Not seat width 33-36)	
Front height (STD 49) - Rear height (STD 44)	

Rear frame	
Aluminium frame	<div style="display: flex; align-items: flex-start;"> <div style="margin-right: 10px;">  </div> <div> <p>☆ Aluminium standard frame - Same colour of front frame</p> <p>The real seat depth, from the front part of the seat cloth to the backrest tube will be 1 cm more than the declared one.</p> <p>camber ☆ 0° <input type="checkbox"/> 1,5° <input type="checkbox"/> 3°</p> </div> </div> <hr/> <div style="display: flex; align-items: flex-start;"> <div style="margin-right: 10px;">  </div> <div> <p><input type="radio"/> Aluminium frame DYNAMIC 2.0 - (COLOUR: BLACK) 09955 337,00</p> <p>The real seat depth, from the front part of the seat cloth to the backrest tube will be 1,5 cm more than the declared one.</p> <p>With rake adjustable backrest (±9°)</p> <p>Exclude the installation of : Brake handles for companion (Drum Brake)</p> <p>camber ☆ 0° <input type="checkbox"/> 1,5° <input type="checkbox"/> 2° <input type="checkbox"/> 4°</p> </div> </div>

Front frame	
<input type="checkbox"/> Short frame - Ideal with Seat depth (PS) 35 - 37,5 Not available for depth 45 - 47,5	Frame Angle ☆ 110° <input type="checkbox"/> 100° <div style="display: flex; justify-content: space-around; margin-top: 10px;">   </div>
<input type="checkbox"/> Medium frame - Ideal with Seat depth (PS) 40 - 42,5 Not available for depth 47,5	
<input type="checkbox"/> Long frame - Ideal with Seat depth (PS) 45 - 47,5	

Frame colour		
Frame colour (without extra charge)		
<input checked="" type="checkbox"/> Opaque black <input type="checkbox"/> POLAR white	<input type="checkbox"/> Tekno anthracite <input type="checkbox"/> Matt Midnight blue	<input type="checkbox"/> Matt grey <input type="checkbox"/> Matt red
Frame colour on request		
<input type="radio"/> Bright silver <input type="radio"/> Bright blue	<input type="radio"/> Bright fuchsia <input type="radio"/> Bright lime	<input type="radio"/> Bright blue china <input type="radio"/> Bright red 12579 109,00

Backrest
☆ Adjustable velcro straps and padded transpiring upholstery

Handle tube	
☆ Tubes with standard handle	
<input type="radio"/> Folding handles Not available with: Push handles for companion, Brake handles for companion (Drum Brake)	 02958 270,00

Date	Order	User	Address
------------	-------------	------------	---------------

Colour set: Includes rear wheel hub and rim, rear wheel plates and front forks
Only standard Progeo 22"/24" wheels have coloured hubs and rims

☆ Black	22" 24" 25" 26"			
<input type="radio"/> Bright silver	22" 24"	00833		135,00
<input type="radio"/> Bright lime	22" 24"	00833		135,00
<input type="radio"/> Bright blue	22" 24"	00833		135,00
<input type="radio"/> Bright red	22" 24"	00833		135,00
<input type="radio"/> Bright fuchsia	22" 24"	00833		135,00
<input type="radio"/> POLAR white	22" 24"	00833		135,00
<input type="radio"/> Tekno anthracite	22" 24"	00833		135,00
<input type="radio"/> Matt Midnight blue	22" 24"	00833		135,00
<input type="radio"/> Matt grey	22" 24"	00833		135,00
<input type="radio"/> Matt red	22" 24"	00833		135,00

Casters

☆ 5" Soft				
<input type="checkbox"/> 4" Soft				
<input type="checkbox"/> 3" Sport		<i>Lightest configuration</i>		
<input type="checkbox"/> 6" Soft		(Available only with 110° angle)		
<input type="checkbox"/> 6" Pneumatic		(Available only with 110° angle)		
<input type="checkbox"/> 7" Soft		(Available only with 110° angle)		
<input type="radio"/> 3" Active Soft (wide)	(Aluminium alloy rim)		06824	95,00
<input type="radio"/> 4" Active Sport (narrow)	(Aluminium alloy rim)		01398	95,00
<input type="radio"/> 4" Active Soft (wide)	(Aluminium alloy rim)		03943	95,00
<input type="radio"/> 5" Active Soft (wide)	(Aluminium alloy rim)		07518	95,00
<input type="radio"/> 5" Pneumatic			10844	68,00

Rear wheels

☆ 24" Ultra-light Progeo - Standard!				
<input type="checkbox"/> 22" Ultra-light Progeo - Standard!				
<input type="checkbox"/> 25" Ultra-light Progeo - Standard!	(colour: black)			
<input type="checkbox"/> 26" Progeo - Standard!	(colour: black)			
<input type="radio"/> 24" ULTRA-LIGHT PROGEO KEY SPORT	<i>Lightest configuration</i>		04383	695,00
<input type="radio"/> 24" Ultra-light "Spinergy LX"			01685	695,00
<input type="radio"/> 24" Ultra-light "Spinergy LXL"	<input type="checkbox"/> Black hub and white spokes	<input type="checkbox"/> Hub and spokes black	07846	695,00
<input type="radio"/> 24" Ultra-light "Spinergy Flex rim"	Integrated aluminium/rubber handrim		02270	1.150,00
<input type="radio"/> 25" Ultra-light "Spinergy LX"			02101	695,00
<input type="radio"/> 25" Ultra-light "Spinergy LXL"	<input type="checkbox"/> Black hub and white spokes		07847	695,00
<input type="radio"/> 26" Ultra-light "Spinergy LX"			02102	695,00
<input type="radio"/> 24" Off-road (aluminium handrim black - Wheel distance 4cm)			01392	270,00
<input type="radio"/> 24" with brake handles for companion (drum brake) (aluminium handrim - Wheel distance 3cm)			03384	386,00
Available only with camber 0°				
Not available with Frame Dynamic 2.0°				
<input type="radio"/> One arm drive - (24" rear wheels Aluminium handrim High pressure Tyre) - camber 0°				
	<input type="radio"/> Right	<input type="radio"/> Left	02103	430,00





Rear wheel tyre

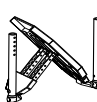
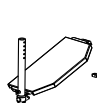

☆ High pressure tyre	(22"-24"-25"-26")	<i>Lightest configuration</i>		
<input type="checkbox"/> High pressure profile tyre	(24")			
<input type="radio"/> Marathon Plus	(24"-25")	with anti-puncture protection	01669	95,00
<input type="radio"/> Anti-puncture - Colour Black	(24")		11083	95,00
Not available with Rear wheels : 24" ULTRA-LIGHT PROGEO KEY SPORT, 24" Ultra-light "Spinergy LXL"				
<input type="radio"/> Anti-puncture - Colour Grey	(22")		04181	105,00

Date	Order	User	Address
------------	-------------	------------	---------------



Handrim	Wheel distance ☆ 3 cm □ 4 cm			
☆ Aluminium	(22"-24"-25"-26")	<i>Lightest configuration</i>		
<input type="radio"/> Aluminium black SOFT-TOUCH	(24"-25")	(24" handrim, on 25" wheel is installed with spacers)	09170	160,00
<input type="radio"/> Chromed Steel	(24"-25")	(24" handrim, on 25" wheel is installed with spacers)	01684	160,00
<input type="radio"/> Titanium	(24"-25")	(24" handrim, on 25" wheel is installed with spacers)	00016	290,00
<input type="radio"/> Ultra Grepp	(24"-25")	(24" handrim, on 25" wheel is installed with spacers)	00017	290,00
<input type="radio"/> TOP FRICTION Oval countour with a rubber insert	(24"-25")	(24" handrim, on 25" wheel is installed with spacers)	11023	290,00
<input type="radio"/> NOVA H Ergonomic black profile	(24"-25")	(24" handrim, on 25" wheel is installed with spacers)	11025	290,00
<input type="radio"/> NOVA D Ergonomic profile with rubber coating (ideal for quadriplegics)	(24"-25")	(24" handrim, on 25" wheel is installed with spacers)	11026	290,00
<input type="radio"/> Silicon cover for standard aluminium handrim		Available for measures (22" - 24" - 26")	04050	172,00

Wheel locks				
☆ Bent lever push to lock				
<input type="checkbox"/> Straight lever push to lock				
<input type="checkbox"/> Straight lever pull to lock				
<input type="checkbox"/> Sport brake		06428		135,00
<input type="checkbox"/> Brake with extension lever push to lock		01949		68,00
<input type="checkbox"/> Brake with extension lever pull to lock		03372		68,00





Footplate - See reference tables N°3				
☆ Plastic footrest, rake adjustable (Minimum footplate distance 33cm.)	☆ 2/3 Internal □ 2/3 External		11525	
<input type="checkbox"/> Automatic Closure footplate , rake and depth adjustable (Minimum footplate distance 30cm.)	<input type="checkbox"/> Internal ☆ 2/3 Internal □ External		11526	
<input type="radio"/> Minimum footplate distance 25cm. Available only with Multi-function and rotative system - 03945	203,00			
<input type="checkbox"/> One piece footplate - Flip-up! rake and depth adjustable (Minimum footplate distance 30cm.)	<input type="checkbox"/> Internal ☆ 2/3 Internal □ External		11527	
<input type="radio"/> Minimum footplate distance 25cm. Available only with Multi-function and rotative system - 03945	203,00			
<input type="checkbox"/> One piece aluminium footplate - Flip-up! rake and depth adjustable (Minimum footplate distance 30cm.)	<input type="checkbox"/> Internal ☆ 2/3 Internal □ 2/3 External □ External		11528	
<input type="radio"/> One piece Carbon fibre footplate rake adjustable, swing away, flip-up. (Minimum footplate distance 30cm.)	☆ Internal □ External		03291	294,00
<input type="radio"/> Footplate COMPACT, automatic Closure, rake and depth adjustable Minimum footplate distance 35cm.	☆ Internal □ External		09957	270,00



Mudguard				
Mudguard - FIXED				
☆ ABS mudguard			03946	337,00
<input type="checkbox"/> ABS Straight sideguard			08918	337,00
<input type="radio"/> Carbon fibre mudguard				
<input type="radio"/> Carbon fibre Straight sideguard				
<input type="checkbox"/> Mudguard enlargement				
☆ + 0 cm				
<input type="checkbox"/> + 1 cm <input type="checkbox"/> + 2 cm	Not available with Rear wheels with brake handles for companion (Drum Brake)		12648	
Mudguard - REMOVABLE				
<i>The distance between the two side guards is 1 cm wider than the seat width</i>				
<input type="radio"/> Removable ABS mudguard			08921	135,00
<input type="radio"/> Removable ABS fibre straight sideguard			08921	135,00
<input type="radio"/> Removable carbon fibre mudguard			08919	466,00
<input type="radio"/> Removable Carbon fibre straight sideguard			08920	466,00

Date	Order	User	Address
------------	-------------	------------	---------------

Armrests			
<i>Tubular armrests with standard support combined with anti-tipper wheels exclude the possibility of installing the transit wheels.</i>			
<input type="radio"/> Tubular armrests	(Swing away, removable and height adjustable armrest) <input type="radio"/> Standard Support (Not with frame Dynamic) <input type="radio"/> Steel support with safety locking system		04828 189,00 00694 270,00
Removable armrest with integrated mudguard			
<input type="radio"/> Desk armrests PROGEO	(Removable and height adjustable) Not available with Frame Dynamic 2.0 + camber 4°		09956 240,00
<input type="checkbox"/> Enlargement of Desk armrests PROGEO			
☆ + 0 cm			
<input type="checkbox"/> + 2 cm			
Available only with Ultra-light Progeo standard wheels and camber 0°			12648
<input type="radio"/> Flip-up armrests PROGEO	(Removable and height adjustable) Not available with Frame Dynamic 2.0		12277 240,00
<input type="radio"/> Removable armrest with ABS straight sideguard	<i>The distance between the two side guards is 1 cm wider than the seat width</i>		08881 240,00
<input type="radio"/> Removable armrest with carbon-fiber straight sideguard	<i>The distance between the two side guards is 1 cm wider than the seat width</i>		08882 486,00

Accessories			
<input type="radio"/> Pad for front frame protectors			07058 56,00
<input type="radio"/> Backrest-seat connection cloth			10241 25,00
<input type="radio"/> Removable storage bag (with quick coupling)			09811 135,00

Optional 1			
<input type="radio"/> Transit wheels			00836 158,00
<input type="radio"/> Anti-tipper with rapid hookup	(inside rotation to reduce the encumbrance) <input type="radio"/> Right <input type="radio"/> Left		00023 145,00 00024 145,00
<input type="radio"/> Tipping aid	<input type="radio"/> Right <input type="radio"/> Left		00025 79,00 01046 79,00
<input type="radio"/> Crutches support	<input type="radio"/> Right <input type="radio"/> Left		00838 79,00 00837 79,00

Optional 2			
<input type="radio"/> Tetraclip	(Quick release axle for quadriplegic)		03947 189,00
<input type="radio"/> Rear wheels plate extension	(Not with frame Dynamic 2.0)		01950 189,00
<input type="radio"/> Handybike adaptor			00506 96,00
<input type="radio"/> Push handles for companion	(Removable and height adjustable)		01048 203,00
<input type="radio"/> Harness			04103 145,00
<input type="radio"/> Safety pelvic belt			03972 68,00
<input type="radio"/> Tray table (removable)			00508 294,00
<input type="radio"/> Lumbar support	(to insert in the backrest upholstery)		00013 43,00
<input type="radio"/> Super Head rest	(Folding with the wheelchair)		04049 486,00
<input type="radio"/> Swing away lateral support	<input type="radio"/> Right <input type="radio"/> Left		02097 270,00 02098 270,00
Not available with Posture backrest PHYSIO			
<input type="radio"/> Spoke guards Black	(22"-24")		01043 158,00
<input type="radio"/> Spoke guards Transparent	(22"-24")		00835 158,00
<input type="radio"/> Spoke guards Progeo design	(22"-24")		00019 189,00







Additional Kit			
<input type="radio"/> 24" Off-road rear wheels	Off-Road tyre - aluminium handrim (black colour)		03378 534,00
<input type="radio"/> 24" FAT rear wheels	FAT tyre 3" - aluminium handrim (black colour)		09357 895,00

Date Order User Address

PHYSIO - Posture backrest - Std. Backrest upholstery not provided



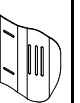

Removable with quick release
 Suitable for tubes with diameter 18÷26mm
 Depth adjustment (4cm)
 Angle adjustment (±18°)

- AIR** Carbon shell
 not available for seat width 48

BACKREST HEIGHT	28	34	40			
Shell's shape 	Lateral retaining wing A=high - R=regular					
	A	R	A	R	A	R
						
	<input type="checkbox"/>	<input type="checkbox"/>	<input type="checkbox"/>	<input type="checkbox"/>	<input type="checkbox"/>	<input type="checkbox"/>

1.121,00

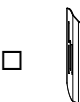
- POSTURE** Aluminum shell

BACKREST HEIGHT	34	40	52
Shell's shape 	Lateral retaining wing R=regular		
	R	R	R
			
	<input type="checkbox"/>	<input type="checkbox"/>	<input type="checkbox"/>

1.085,00

Configuration DEEP with side support PAD (height adjustable)

Alluminum lateral with padded, breathable upholstery.



Small (h 13cm)



- Right 10272 **49,00**
- Left 10272 **49,00**

Large (h 20cm)



- Right 10273 **49,00**
- Left 10273 **49,00**

SWING AWAY - Lateral support

Fixing and adjustment hardware complete with protection sleeve
 Aluminum lateral with padded, breathable upholstery.

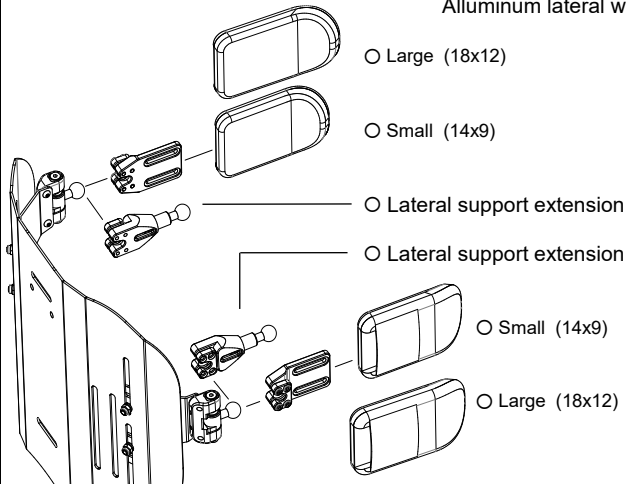

- Large (18x12) **05647 196,00**
- Small (14x9) **05643 196,00**
- Lateral support extension
 Quantity (number pcs)..... **10271 74,00**
- Lateral support extension
 Quantity (number pcs).....
- Small (14x9) **05642 196,00**
- Large (18x12) **05646 196,00**

- Headrest adjustable - Double ball mounting system
 Available only with backrest Physio Posture

- Large (35x12,5) **05648 385,00**
- Small (25x12,5)





Date	Order	User	Address
------------	-------------	------------	---------------

Note

Wheelchair : Progeo EXELLE - Rev. 2026.0	Prices - VAT excluded <small>to be added to the price list</small>	Send this page only if any optional have been chosen <input checked="" type="checkbox"/> standard <small>(supplied if no requests are indicated)</small> <input type="checkbox"/> on request <small>(without extra charge)</small> <input type="checkbox"/> optional <small>(cost to be added at the basic price)</small>
---	--	--

REFERENCE TABLES

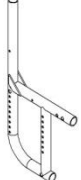
1	Front height	
With closed frame (95°) max 5" caster		
Casters	Front height	
	min.	max
3"	41	52
4"	42	53
5"	44	54
6"	48	55
7"	50	56
The size of the fork will be defined only by Progeo in accordance with wheelchair final configuration.		

2	Rear height				
	Rear frame	Rear wheels			
		22"	24"	25"	26"
STANDARD	Straight plate 	min. 37 max 45	min. 39 max 47	min. 40 max 48	min. 41 max 49
	Shaped plate 	min. 36 max 49	min. 38 max 51	min. 39 max 52	min. 40 max 53
	Rear wheels plate extension 	min. 37 max 46	min. 39 max 48	min. 40 max 50	min. 41 max 51
DYNAMIC 2.0	with Tubular armrests 	min. 39 max 46	min. 41 max 48	min. 43 max 50	min. 44 max 51
		min. 36 max 49	min. 38 max 51	min. 39 max 52	min. 40 max 53

3	Footplate option	Footplate distance	
		Frame Angle 110°	Frame Angle 100°
	Plastic footrest	min. 33	min. 31
	Automatic Closure footplate	min. 30	min. 28
	Automatic Closure footplate , with multifunction rotative system	min. 25	min. 23
	One piece footplate - Flip-up!	min. 30	min. 28
	One piece footplate - Flip-up! , with multifunction rotative system	min. 25	min. 23
	One piece aluminium footplate - Flip-up!	min. 30	min. 28
	One piece Carbon fibre footplate	min. 30	min. 28
Calculated with the best configuration and with the footplates positioned on inside.			
IMPORTANT NOTICE! From the footplate to the floor minimum 4cm !! (Minimum Front height = DP + 4cm)			

4	Rear wheels	
	Model	Features
	22" Ultra-light Progeo - Standard!	(not available in anthracite color)
	24" Ultra-light Progeo - Standard!	(available for all coulores)
	24" ULTRA-LIGHT PROGEO KEY SPORT	(silver hub, black rim and 16 spokes)
	24" Ultra-light "Spinergy LX"	(silver hub, black rim and spokes)
	24" Ultra-light "Spinergy LXL"	(black hub and rim, 18 white spokes) - (black hub, rim and 18 spokes)
	24" Ultra-light "Spinergy Flex rim"	(silver hub, black rim and spokes) - (integrated aluminium/rubber handrim - encumbrance reduction up to 3cm. - all tyre)
	24" Off-road	(colour: black) - (aluminium handrim - tyre Off-road)
	25" Ultra-light "Spinergy LX"	(silver hub, black rim and spokes)
	25" Ultra-light "Spinergy LXL"	(black hub and rim, 18 white spokes)
	26" Progeo - Standard!	(colour: black)
	26" Ultra-light "Spinergy LX"	(silver hub, black rim and 18 spokes)

Wheelchair : Progeo EXELLE - Rev. 2026.0

Date	Order	User	Address
------	-------	------	---------

12" wheel - Motor 250W (750W maximum power)
 14" wheel - Motor 1000W (1500W maximum power)

- Color display with switcher
- Maximum speed limit settable from display
- 5 speed levels selectable
- 10 display-selectable acceleration levels
- Adaptive Cruise Control
- Disc and electronic brake control lever
- Motor brake (adjustable in 10 levels from the display)
- Electronic brake with control bottom (adjustable in 10 levels from the display)
- Power regain when braking
- Error messages management from display (with error history)
- Rear gear beeper
- 48V - 5.8 Ah battery Autonomy up to 25km
- 48V - 11.6 Ah Power plus battery Autonomy up to 50km
- Battery charger 48V
- Rear gear
- USB port
- Easle
- Mudguard
- Front spoiler with predisposition for FULL LED light

(Certified software)

Mototronik

10979 N/A



Handlebar

☆ STANDARD controls

☆ Thumb accelerator

☆ Right
12592

Left
12593

Grip throttle

Right
10913

Left
10914

Disc and electronic brake control lever

☆ Right
12594

Left
12595

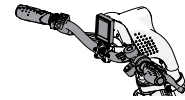

42,00

QUADRIPLEGIC controls
 Handlebar PUSH&PULL

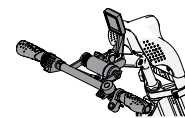

10905 428,00

☆ **MOTOTRONIK 12" wheel**

Motor 250W (750W maximum power)
 Maximum speed according to law

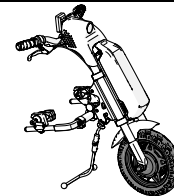

MOTOTRONIK 14" wheel

Motor 1000W (1500W maximum power)
 Maximum speed according to law

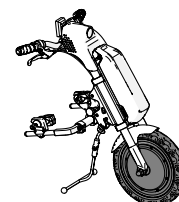

10903 428,00

Battery





☆ 48V - 5.8 Ah battery *Autonomy up to 25 km*

48V - 11.6 Ah Power plus battery *Autonomy up to 50 km*

10904 289,00

Date Order User Address

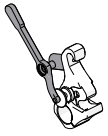
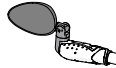
Accessories

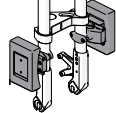
- | | | | | |
|---|---|---|--------|--------|
| <input type="radio"/> FULL LED light (high intensity)
Integrated in the spoiler |  | 10908 | 107,00 | |
| <input type="radio"/> Handlebar extension
Adjustable from 15cm up to 23cm |  | 10907 | 182,00 | |
| <input type="radio"/> Motor unit facilitated unlock lever
Recommended with handlebar for quadriplegic |  | 10915 | 82,00 | |
| <input type="radio"/> Additional FLY 48V - 2.9 Ah battery
Autonomy up to 15km
Approved for air transport | | 10906 | 697,00 | |
| <input type="radio"/> Rearview mirror | <input type="radio"/> Right
<input type="radio"/> Left |  | 10909 | 32,00 |
| <input type="radio"/> Basket (removable) - (with KLICKfix® attachment system) | |  | 10912 | 212,00 |
| <input type="radio"/> Removable front weight - (with KLICKfix® attachment system)
(it increases the weight over the power wheel to improve traction) | |  | 10910 | 311,00 |
| <input type="radio"/> Travel bag | | | 10916 | 155,00 |

Note

Send this page only if any optional have been chosen

- | | | |
|---|------------|---|
| ☆ | standard | (supplied if no requests are indicated) |
| □ | on request | (without extra charge) |
| ○ | optional | (cost to be added at the basic price) |