

Vicair® Adjuster O2 & Vicair® Adjuster O2 LOW

(Only available with Kwik Strap)

ORDER FORM

HCPCS CODING: E2622/E2623
ADJUSTABLE SKIN PROTECTION



Company Name/ACCT #: _____
 P.O. Number: _____
 Requested By: _____
 Phone: _____ Fax: _____
 Email: _____
 Ship To: _____
 Client Reference: _____



Adjuster O2

For best results, do not fill out in your browser. Interactive form should be completed using Adobe Reader after saving to your local drive. Then email or print and fax to Customer Support at orders.comfort@permobil.com or 1.406.522.8563.

DO NOT SEND PROTECTED HEALTH INFORMATION. IT IS NOT NEEDED TO MAKE THE PRODUCT YOU ARE REQUESTING.

1 SIZE & STYLE

INCOTEC
FOR FLUID PROTECTION & AN EASILY CLEANED SURFACE.



COMFAIR
FOR USER COMFORT & HEAT DISSIPATION.

Choose the fabric type and size for the Adjuster O2 Standard Profile. If a Kwik Strap is needed, choose a size on page 2.

ADJUSTER O2 STANDARD

HCPCS CODE: E2622/E2623

 = Nonstock items available at extended lead times and a \$40.00 upcharge.

		INCOTEC								
		\$455.00				\$503.00				
DEPTH	22"					OADS-CI-1822	OADS-CI-1922	OADS-CI-2022	OADS-CI-2222	OADS-CI-2422
	21"					OADS-CI-1921				
	20"			OADS-CI-1620	OADS-CI-1720	OADS-CI-1820	OADS-CI-1920	OADS-CI-2020	OADS-CI-2220	OADS-CI-2420
	19"			OADS-CI-1619	OADS-CI-1719	OADS-CI-1819	OADS-CI-1919	OADS-CI-2019		
	18"	OADS-CI-1418	OADS-CI-1518	OADS-CI-1618	OADS-CI-1718	OADS-CI-1818	OADS-CI-1918	OADS-CI-2018	OADS-CI-2218	OADS-CI-2418
	17"			OADS-CI-1617	OADS-CI-1717	OADS-CI-1817		OADS-CI-2017		
	16"	OADS-CI-1416	OADS-CI-1516	OADS-CI-1616	OADS-CI-1716	OADS-CI-1816		OADS-CI-2016		
	15"		OADS-CI-1515	OADS-CI-1615						
	14"	OADS-CI-1414								
		14"	15"	16"	17"	18"	19"	20"	22"	24"
		WIDTH								

		COMFAIR								
		\$455.00				\$503.00				
DEPTH	22"					OADS-CC-1822	OADS-CC-1922	OADS-CC-2022	OADS-CC-2222	OADS-CC-2422
	21"					OADS-CC-1921				
	20"			OADS-CC-1620	OADS-CC-1720	OADS-CC-1820	OADS-CC-1920	OADS-CC-2020	OADS-CC-2220	OADS-CC-2420
	19"			OADS-CC-1619	OADS-CC-1719	OADS-CC-1819	OADS-CC-1919	OADS-CC-2019		
	18"	OADS-CC-1418	OADS-CC-1518	OADS-CC-1618	OADS-CC-1718	OADS-CC-1818	OADS-CC-1918	OADS-CC-2018	OADS-CC-2218	OADS-CC-2418
	17"			OADS-CC-1617	OADS-CC-1717	OADS-CC-1817		OADS-CC-2017		
	16"	OADS-CC-1416	OADS-CC-1516	OADS-CC-1616	OADS-CC-1716	OADS-CC-1816		OADS-CC-2016		
	15"		OADS-CC-1515	OADS-CC-1615						
	14"	OADS-CC-1414								
		14"	15"	16"	17"	18"	19"	20"	22"	24"
		WIDTH								

QUESTIONS? PLEASE CONTACT CUSTOMER SUPPORT FOR ASSISTANCE. | 800.736.0925

ADJUSTER O2 STANDARD WITH KWIK STRAP

		INCOTEC				
		\$465.00			\$513.00	
DEPTH	20"	OADS-CI-1620-KS	OADS-CI-1820-KS	OADS-CI-2020-KS	OADS-CI-2220-KS	OADS-CI-2420-KS
	18"	OADS-CI-1618-KS	OADS-CI-1818-KS	OADS-CI-2018-KS	OADS-CI-2218-KS	OADS-CI-2418-KS
	16"	OADS-CI-1616-KS	OADS-CI-1816-KS	OADS-CI-2016-KS		
		16"	18"	20"	22"	24"
		WIDTH				

ADJUSTER O2 LOW WITH KWIK STRAP

		INCOTEC		
		\$465.00		
DEPTH	20"	OADL-CI-1620-KS	OADL-CI-1820-KS	OADL-CI-2020-KS
	18"	OADL-CI-1618-KS	OADL-CI-1818-KS	OADL-CI-2018-KS
	16"	OADL-CI-1616-KS	OADL-CI-1816-KS	OADL-CI-2016-KS
		16"	18"	20"
		WIDTH		

2 ADJUSTER O2 ACCESSORIES

2.1 REMOVABLE SOLID SEAT PAN & HARDWARE KIT HCPCS Code: E2231 MSRP \$387.00

The solid seat pan kit includes a slotted aluminum pan and attaching hardware to accommodate 7/8" or 1" tubing. The kit also comes with two different cross bars to accommodate various wheelchair frame types. This will fit both folding and non-folding seat rails. Lateral thigh support hardware can be easily attached.

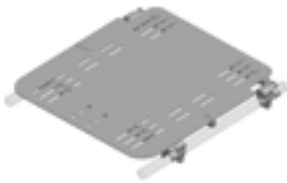

Solid Seat Pan & Hardware Kit
(RSSP-1-___)

2.2 EXTRA VICAIR® AIR CELLS MSRP \$43.00 / 50 air cell pack



Pack of 50 Vicair® Air Cells (AIRCELL50)

3 BODILINK® LATERAL PELVIC/THIGH SUPPORT HARDWARE & PADS

Please select sizes in the appropriate fabric & style charts below. Contact Customer Support for custom sizes that are not listed below 800.736.0925.

3.1 PREMIUM PAD SIZE & SHAPE HCPCS Code: E0953 MSRP \$66.00

- You may make one selection per column (Left, Extra Left, Right, and Extra Right) in section 3.1.
- Make a fabric selection in 3.2.

*Length (L) refers to the actual size dimension of the support from top to bottom edge. Depth (D) refers to the actual size dimension from anterior to posterior edge.

STYLE	SIZE	LEFT	EXTRA LEFT	RIGHT	EXTRA RIGHT
	3.5"L x 4"D	BL-LPTSP2Z-3L4D-LH	BL-LPTSP2Z-3L4D-LH	BL-LPTSP2Z-3L4D-RH	BL-LPTSP2Z-3L4D-RH
	3.5"L x 8"D	BL-LPTSP2Z-3L8D-LH	BL-LPTSP2Z-3L8D-LH	BL-LPTSP2Z-3L8D-RH	BL-LPTSP2Z-3L8D-RH
	3.5"L x 12"D	BL-LPTSP2Z-3L12D-LH	BL-LPTSP2Z-3L12D-LH	BL-LPTSP2Z-3L12D-RH	BL-LPTSP2Z-3L12D-RH
	5.5"L x 6"D	BL-LPTSP2Z-5L6D-LH	BL-LPTSP2Z-5L6D-LH	BL-LPTSP2Z-5L6D-RH	BL-LPTSP2Z-5L6D-RH

3.2 PREMIUM PAD COVER WITH FOAM INSERT

COVER OPTIONS	MSRP	LEFT		EXTRA LEFT		RIGHT		EXTRA RIGHT	
COMFORT-TEK®	\$0.00/ea.		LPTS-P2-COMFORT-FM		LPTS-P2-COMFORT-FM		LPTS-P2-COMFORT-FM		LPTS-P2-COMFORT-FM
STRETCH-AIR®	\$0.00/ea.		LPTS-P2-STRETCH-FM		LPTS-P2-STRETCH-FM		LPTS-P2-STRETCH-FM		LPTS-P2-STRETCH-FM
GLIDEWEAR®	\$13.00/ea.		LPTS-P2-GLIDE-FM		LPTS-P2-GLIDE-FM		LPTS-P2-GLIDE-FM		LPTS-P2-GLIDE-FM

COMFORT-TEK®
FOR FLUID PROTECTION & AN EASILY CLEANED SURFACE.

STRETCH-AIR®
FOR USER COMFORT & HEAT DISSIPATION.

GLIDEWEAR®
FOR SKIN PROTECTION & SHEAR REDUCTION. NOT FLUID RESISTANT.

- You may make one selection per column (Left, Extra Left, Right, and Extra Right) in section 3.3 from group A, B, or C.
- TT long extension arms (section 3.4) will only work with TT style hardware.

3.3 BODILINK® LATERAL PELVIC/THIGH SUPPORT HARDWARE

A. TT HARDWARE, SLOT MOUNT

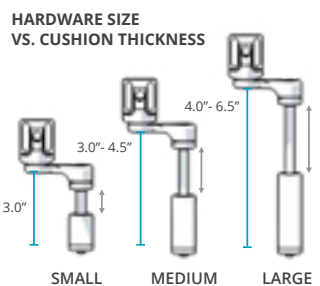

HARDWARE SIZE	MAX CUSHION THICKNESS CLEARANCE	RECOMMENDED CUSHION THICKNESS
SMALL	3.0"	2.0" - 3.0"
MEDIUM	4.5"	3.0" - 4.5"
LARGE	6.5"	4.0" - 6.5"

FIXED	SIZE	MSRP	LEFT		EXTRA LEFT		RIGHT		EXTRA RIGHT	
	SMALL	\$149.00		BL-LPTS-TT1FXSL1-LH		BL-LPTS-TT1FXSL1-LH		BL-LPTS-TT1FXSL1-RH		BL-LPTS-TT1FXSL1-RH
MEDIUM	\$149.00		BL-LPTS-TT1FXSL2-LH		BL-LPTS-TT1FXSL2-LH		BL-LPTS-TT1FXSL2-RH		BL-LPTS-TT1FXSL2-RH	
LARGE	\$149.00		BL-LPTS-TT1FXSL3-LH		BL-LPTS-TT1FXSL3-LH		BL-LPTS-TT1FXSL3-RH		BL-LPTS-TT1FXSL3-RH	
OR										
REMOVABLE E1028	SIZE	MSRP	LEFT		EXTRA LEFT		RIGHT		EXTRA RIGHT	
	SMALL	\$261.00		BL-LPTS-TT1RMSL1-LH		BL-LPTS-TT1RMSL1-LH		BL-LPTS-TT1RMSL1-RH		BL-LPTS-TT1RMSL1-RH
	MEDIUM	\$261.00		BL-LPTS-TT1RMSL2-LH		BL-LPTS-TT1RMSL2-LH		BL-LPTS-TT1RMSL2-RH		BL-LPTS-TT1RMSL2-RH
LARGE	\$261.00		BL-LPTS-TT1RMSL3-LH		BL-LPTS-TT1RMSL3-LH		BL-LPTS-TT1RMSL3-RH		BL-LPTS-TT1RMSL3-RH	

B. TT HARDWARE, POWER MOUNT

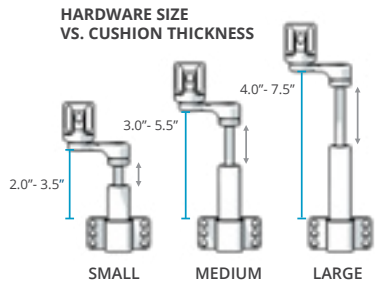

HARDWARE SIZE	MAX CUSHION THICKNESS CLEARANCE	RECOMMENDED CUSHION THICKNESS
SMALL	3.5"	2.0" - 3.5"
MEDIUM	5.5"	3.0" - 5.5"
LARGE	7.5"	4.0" - 7.5"

FIXED	SIZE	MSRP	LEFT		EXTRA LEFT		RIGHT		EXTRA RIGHT	
	SMALL	\$195.00		BL-LPTS-TT1FXPWL1-LH		BL-LPTS-TT1FXPWL1-LH		BL-LPTS-TT1FXPWL1-RH		BL-LPTS-TT1FXPWL1-RH
	MEDIUM	\$195.00		BL-LPTS-TT1FXPWL2-LH		BL-LPTS-TT1FXPWL2-LH		BL-LPTS-TT1FXPWL2-RH		BL-LPTS-TT1FXPWL2-RH
LARGE	\$195.00		BL-LPTS-TT1FXPWL3-LH		BL-LPTS-TT1FXPWL3-LH		BL-LPTS-TT1FXPWL3-RH		BL-LPTS-TT1FXPWL3-RH	
OR										
REMOVABLE E1028	SIZE	MSRP	LEFT		EXTRA LEFT		RIGHT		EXTRA RIGHT	
	SMALL	\$300.00		BL-LPTS-TT1RMPWL1-LH		BL-LPTS-TT1RMPWL1-LH		BL-LPTS-TT1RMPWL1-RH		BL-LPTS-TT1RMPWL1-RH
	MEDIUM	\$300.00		BL-LPTS-TT1RMPWL2-LH		BL-LPTS-TT1RMPWL2-LH		BL-LPTS-TT1RMPWL2-RH		BL-LPTS-TT1RMPWL2-RH
LARGE	\$300.00		BL-LPTS-TT1RMPWL3-LH		BL-LPTS-TT1RMPWL3-LH		BL-LPTS-TT1RMPWL3-RH		BL-LPTS-TT1RMPWL3-RH	

TT HARDWARE, POWER MOUNT OPTION

NOTE: If choosing the Power Mount Hardware, choose the appropriate power mount type below.

POWER MOUNT	MSRP	PART NUMBER
QUANTUM	add \$0.00	LPTS-TT1-PW1
PERMOBIL	add \$0.00	LPTS-TT1-PW2
QUICKIE	add \$0.00	LPTS-TT1-PW3
ROVI	add \$0.00	LPTS-TT1-PW4
AVID REHAB	add \$0.00	LPTS-TT1-PW5

3.4 TT LONG EXTENSION ARM 4" MSRP \$39.00/arm



LEFT	EXTRA LEFT	RIGHT	EXTRA RIGHT
BL-LPTS-TT1LARM4	BL-LPTS-TT1LARM4	BL-LPTS-TT1LARM4	BL-LPTS-TT1LARM4

4 BODILINK® MEDIAL KNEE/THIGH SUPPORT HARDWARE & PADS

- You may make one selection per column.
- Choose between wedge or oval in 4.1.
- Choose a cover material in 4.2.
- Choose hardware size in 4.3.

4.1 PAD SIZE & SHAPE

HCPCS CODING: E0957 MSRP \$137.00

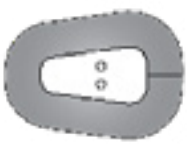
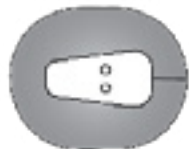
STYLE	SIZE	PART NUMBER
 WEDGE	2.5"W x 3.5"D	BL-MKTSP1-3W4D
	3.5"W x 5"D	BL-MKTSP1-4W5D
	4"W x 6"D	BL-MKTSP1-4W6D
 OVAL	2.5"W x 3.5"D	BL-MKTSP2-3W4D
	3.5"W x 5"D	BL-MKTSP2-4W5D
	5"W x 6"D	BL-MKTSP2-5W6D

4.2 PAD COVER MATERIAL

	FOR SKIN PROTECTION & SHEAR REDUCTION. NOT FLUID RESISTANT.
	FOR FLUID PROTECTION & AN EASILY CLEANED SURFACE.
	FOR USER COMFORT & HEAT DISSIPATION.

GlideWear® (MKTSP-GLIDE) (add \$15.00)
Comfort-Tek® (MKTSP-COMFORT)
Stretch-Air® (MKTSP-STRETCH)

4.3 MEDIAL KNEE/THIGH SUPPORT SWING AWAY HARDWARE

HCPCS CODING: E1028 MSRP \$189.00

SIZE	PART NUMBER
SMALL	BL-MKTS-ST1SASL1
MEDIUM	BL-MKTS-ST1SASL2
LARGE	BL-MKTS-ST1SASL3

*Swing Away Hardware only, not available in Fixed Hardware
 **MKTS Hardware must be mounted to Removable Solid Seat Pan in section 2.4
 ***If Leg Length Discrepancy is needed on Removable Solid Seat Pan, Offset Orientation must be selected

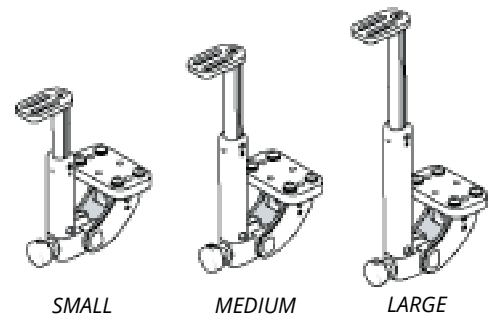
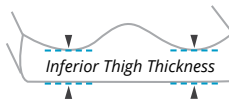

SIZE	RECOMMENDED INFERIOR THIGH THICKNESS
Small	1.00" - 3.00"
Medium	2.00" - 5.00"
Large	3.00" - 7.00"