

TiLite

Options



permobil

Front wheels

- ❶ 3"x1.5" LiteSpeed billet aluminum wheel w/Soft Roll tire
- silver hub OR black hub
- ❷ 4"x.75" plastic wheel w/poly tire
- ❸ 4"x.75" Light-Up Micro Caster
- ❹ 4"x1.5" LiteSpeed billet aluminum wheel w/Soft Roll tire
- silver hub OR black hub
- ❺ 5"x1" plastic wheel w/poly tire
- ❻ 5"x1.5" LiteSpeed billet aluminum wheel w/Soft Roll tire
- silver hub OR black hub
- ❼ 5"x1.5" LiteSpeed plastic wheel w/Soft Roll tire
- ❽ 6"x1.5" LiteSpeed billet aluminum wheel w/Soft Roll tire
- silver hub OR black hub

Options not shown

- 4"x1.5" LiteSpeed plastic wheel w/Soft Roll tire
- 6"x1" plastic wheel w/poly tire
- 6"x1.5" LiteSpeed plastic wheel w/Soft Roll tire
- 8"x1" plastic wheel w/poly tire



Front forks

- ❶ Glide™ Suspension fork
- ❷ TiLite Standard fork
- ❸ TiLite Slipstream Single-Sided fork



Axles

- ❶ Stainless Quick Release
- ❷ Quad Release

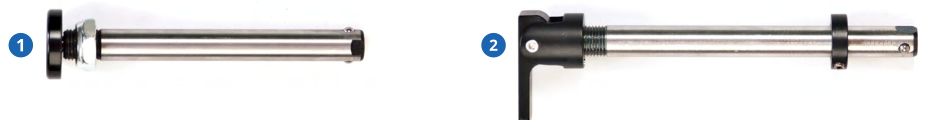

Options not shown

Titanium Quick Release



Rear wheels

Performance rear wheels

- 1 TiLite Shadow
- 2 Spinerdy Carbon Blade
- 3 Spinerdy LX and Design Lab LX
- 4 Spinerdy SPOX
- 5 X-Core Mag

Options not shown

TiLite standard rear wheel



Available in 20"(451), 22"(501), 24"(540), 25"(559) and 26"(590) sizes.



Available in 24"(540) and 25"(559) sizes.



Available in 22"(501), 24"(540), 25"(559) and 26"(590) sizes.



Available in 22"(501), 24"(540), 25"(559) and 26"(590) sizes.



Available in 20"(451), 22"(501) and 24"(540) sizes.

Available spoke colors



*Purple only available in size 22"

Available ano colors



*Spinerdy Design Lab

Available spoke colors





Rear tires

Pneumatic rear tires

- 1 Treaded 22"(501), 24"(540) & 26"(590)
- 2 MBL SpeedLite 20"(451), 22"(501), 24"(540), 25"(559) & 26"(590)
- 3 Schwalbe® Marathon Plus Evolution 24"(540), 25"(559) & 26"(590)
- 4 Primo Sentinel 20"(451), 22"(501) & 24"(540)
- 5 Schwalbe® Slick 24"(540) & 25"(559)
- 6 Primo C-763 knobby tire



1

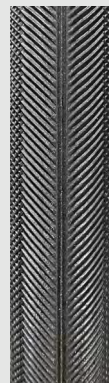

2



3

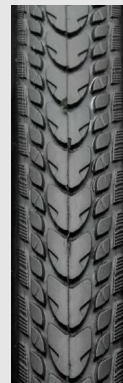

4

Solid rear tires

- 7 Primo Orion 20" (451), 22" (501), 24" (540) & 25" (559) replaces Primo Express
- 8 Primo Active 24"(540) & 25"(559)



5



6



7



8

Handrims

- 1 Aluminum – silver anodized
- 2 Aluminum – black anodized
- 3 Titanium – satin finish
- 4 The Natural-Fit® Standard Grip
Original, Larger Profile
- 5 The Natural-Fit® LT Super Grip
reduced weight, smaller profile
- 6 The Surge
All-in-one oval with Gription™ Strip, larger profile
- 7 The Surge LT
All-in-one oval with Gription™ Strip, smaller profile
- 8 Q-Grip
Exclusive high-friction, anti-slip coating

Options not shown

- The Natural-Fit®
With Super Grip Original, larger profile
- The Natural-Fit®
Without thumb grip original, larger profile
- The Natural-Fit® LT Standard Grip
Reduced weight, smaller profile
- The Natural-Fit® LT
Without thumb grip reduced weight, smaller profile
- Plastic coated – black



Back Upholstery

- 1 Velcro Adjustable
- 2 Tension Adjustable by Straps
- 3 AIR Breathable Upholstery
- 4 AIR Breathable with Lateral and Lumbar Contour Packs.*

Options not shown

Ultrasuede Backrest Stripe

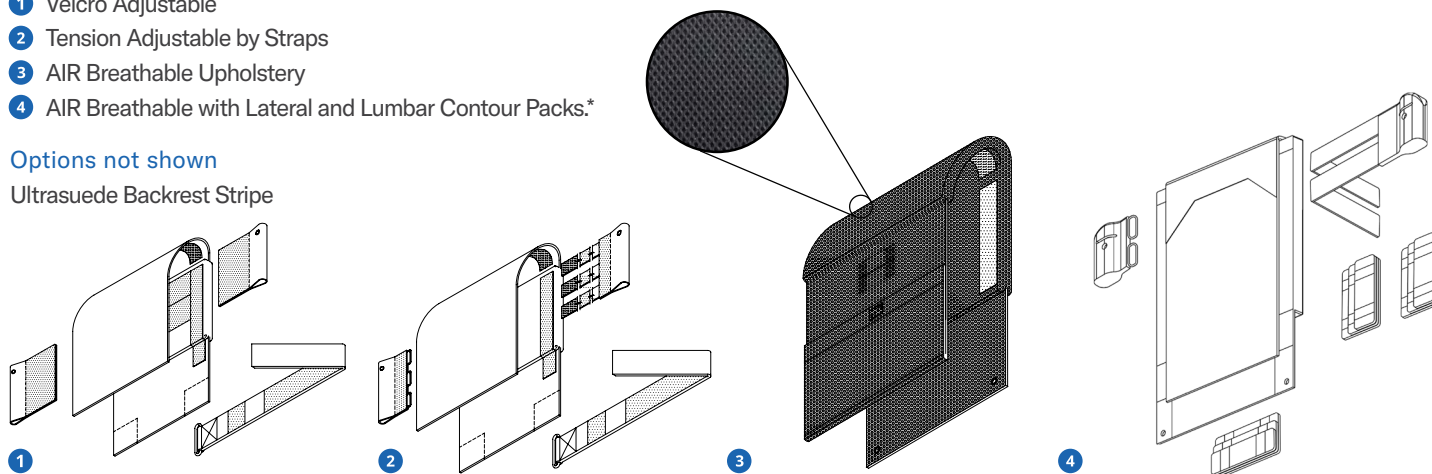

*Only available on TiLite X and TiLite Z

Seat Upholstery

- 1 Tension Adjustable Bolt On
- 2 Tension Adjustable by Straps
- 3 Aluminum Solid Seat
- 4 Tension Adjustable for folding chairs

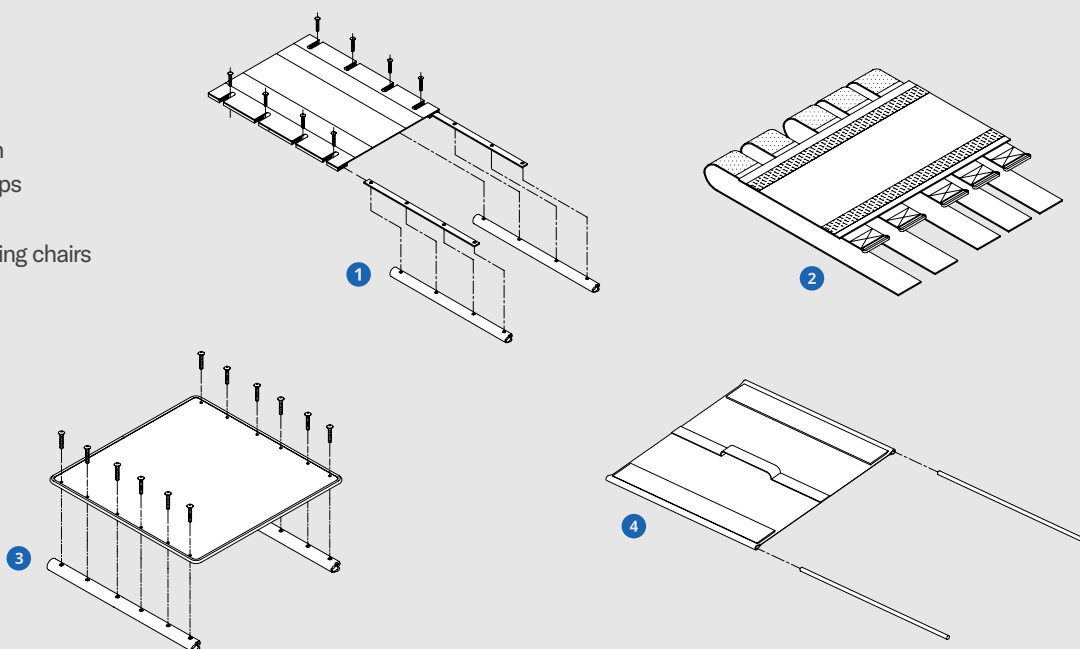

Wheel locks

Composite wheel locks by Out-Front®

- 1 Push OR pull (shown)
- 2 MBL Composite Scissor
- 3 Extension handles for Push OR Pull

Additional wheel locks

- 4 Uni-Lock All-in-One Push OR Pull
- 5 Aluminum Push or Pull

Options not shown

Extension handles for Uni-Lock
Grade Aids Push to Lock





Side guards

- 1 Carbon Fiber Rigid Removable
- 2 Carbon Fiber Quad Removable w/Hole
- 3 Carbon Fiber Fold Down Rigid
- 4 Carbon Fiber Fendered Removable
- 5 Aluminum Fendered Adjustable

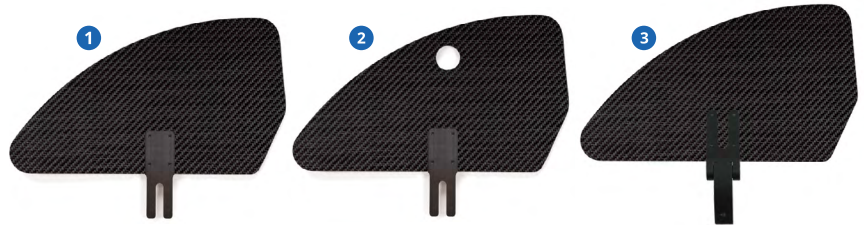

Options not shown

- Aluminum Rigid Removable
- Aluminum Quad Removable w/Hole
- Aluminum Fold Down Rigid

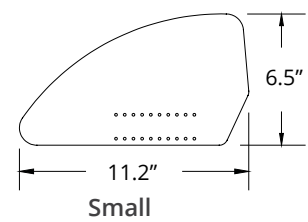
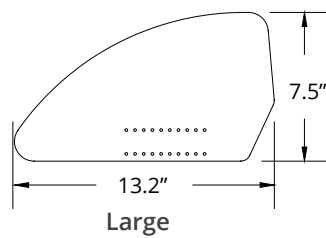



Armrests

- 1 Swing-Away Tubular
- 2 Swing-Away - Flip Back Tubular
- 3 Removable Height Adjustable Desk Arm with Rigid Side Guard
- 4 Removable Height Adjustable Desk Arm with Rigid Side Guard and Transfer Loop 2-Point
- 5 Flip Back OR Removable T-Style Armrest

Options not shown

Covered in black Ultrasuede

Fixed Height Non-Removable Armrest

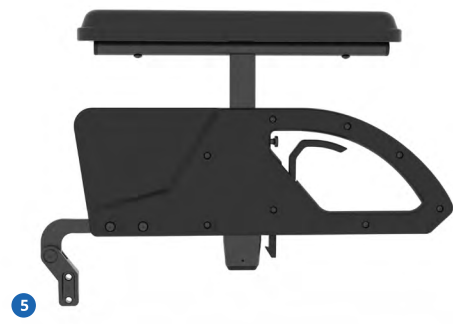

Footrests

Rigid chair footrests

- 1 Angle Adjustable Footrest
- 2 Titanium Footrest w/Flat ABS Cover
- 3 Titanium Open Loop Footrest
- 4 Titanium Flip-Back Footrest
- 5 Flip-Back Depth & Angle Adjustable High Mount Footrest

Folding chair footrests

- 6 Flip-Up Footrest (also available on rigid chairs through CMD 40)
- 7 1-Piece Flip-Up Footrest (CMD Creative Mobility Division)

Options not shown

1-Piece, Over-Center Folding Footrest
Depth Adjustable Flip-Up
Angle Adjustable Flip-Up
Depth and Angle Adjustable Flip-Up
Custom Flip Up Footplates for T-series

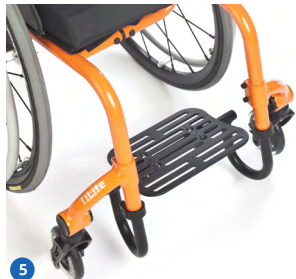
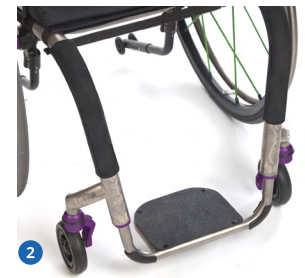

NOTE: For a complete list of Footrest options see TiLite's order forms.

Anti-tips

- 1 User Friendly Rear Flip-up
- 2 Center Mount Swivel Caster (TWIST, available on other chairs through CMD)

Options not shown

Rear Aluminum - Black
Tip Assist
Center Mount Non-Swivel Caster

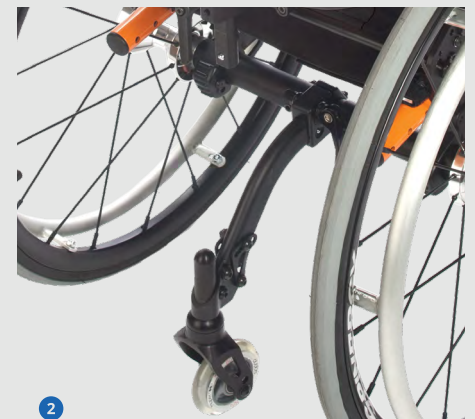
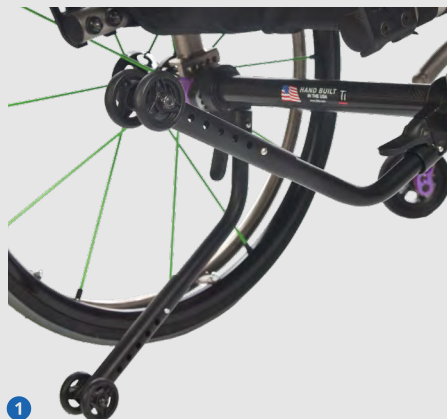

Push handles

- 1 Integrated Push Handles
- 2 Integrated Fold Down Push Handles
- 3 Bolt On Push Handles
- 4 Bolt On Center Mount Height-Adjustable Push Handle
(a TWIST style backrest is required)

Options not shown

Bolt On Height-Adjustable Push Handles
TWIST Stroller Handle



Additional options

- 1 Carbon Fiber TiShaft™ Back Release Bar - Also available in **SB3** Aluminum
- 2 Neoprene Impact Guards with Ultrasuede Stripe
- 3 Permobil Medical Necessities Seat Pouch, **BCK3** Permobil Medical Necessities Backpack & **PCH4** Bodypoint® Mobility Bag
- 4 4" Military Logo Patches
- 5 Luggage Carriers
- 6 Zero Play Aluminum Camber Plugs, **CBR12** Adjustable Rear Wheel Spacing Camber Plugs
- 7 Rounded Titanium Rigidizer Bar - Available on rigid chairs (not available on the TWIST)

Options not shown

Residual limb support

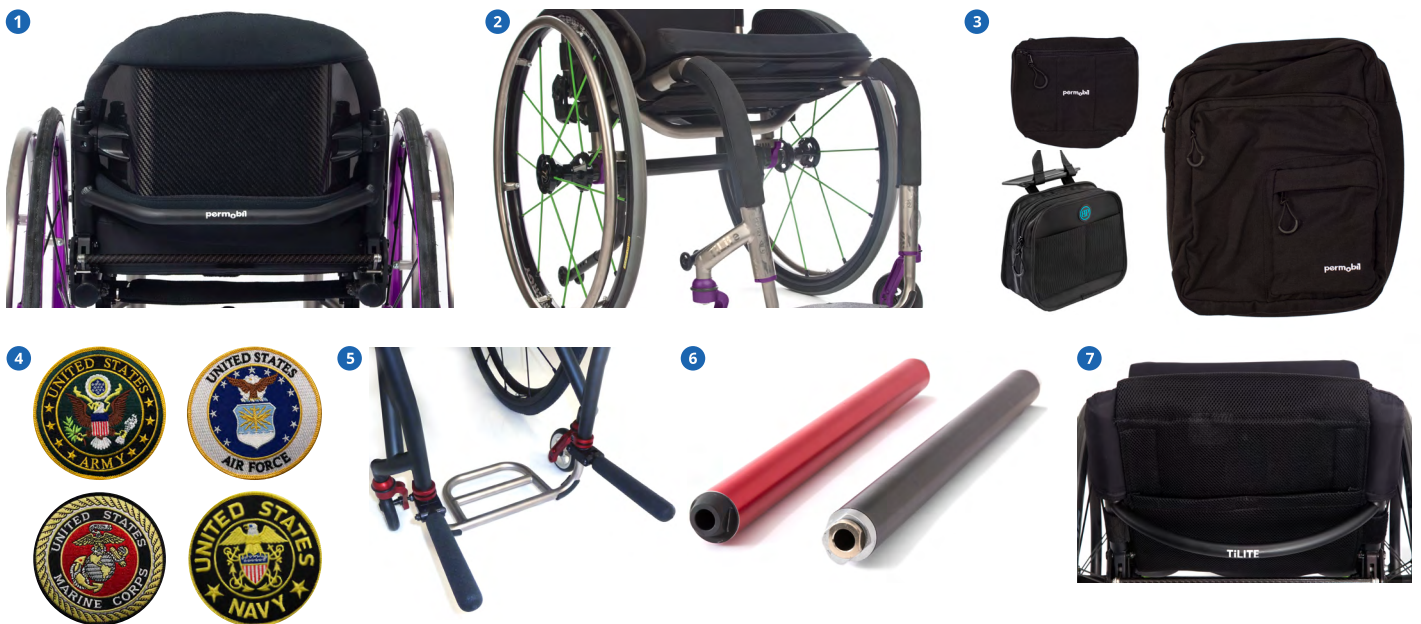

NOTE: Not all options are available on all models. See order forms for availability and pricing. Prices, standard features, options and accessories are subject to change without notice.



Tattoo options

- 1 Mosaic
- 2 Flower garden
- 3 Need for speed



- 1
- 2
- 3

Frame colors

High gloss paint

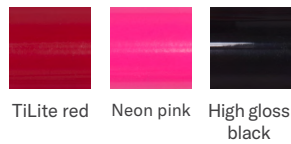

TiLite red Neon pink High gloss black

Metallic paint

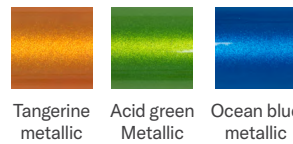

Tangerine metallic Acid green Metallic Ocean blue metallic

Pearlescent paint



Midnight blue pearl White pearl

Matte paint

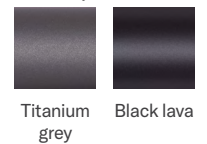

Titanium grey Black lava grey

Candy paint N/A TiLite Z or TiLite X

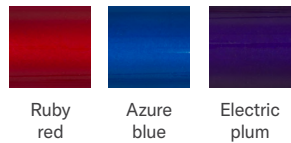

Ruby red Azure blue Electric plum

Matte textured paint

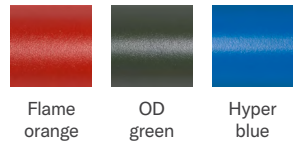

Flame orange OD green Hyper blue

Natural Titanium

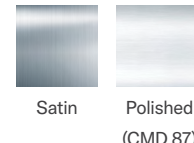

Satin Polished (CMD 87)

TiLite Z and TiLite X exclusive frame colors

High gloss paint

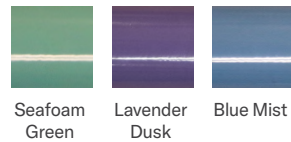

Seafoam Green Lavender Dusk Blue Mist

Metallic paint

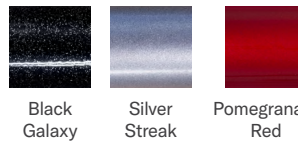

Black Galaxy Silver Streak

Candy paint

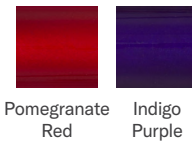

Pomegranate Red Indigo Purple

Component colors

Anodized



Red Orange Blue Purple Green Gold Black

Creative Mobility Division (CMD)

TiLite understands that everyone has different postural and mobility needs, and while our order forms meet the needs of most users, sometimes you need individual solutions.

Through CMD, customers are able to work with our team of engineers, customer experience, and production to come up with creative solutions to their unique needs.

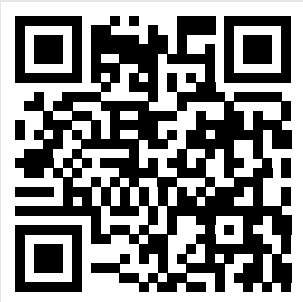

Scan to view full CMD catalogue



TiFit for foot-propelling customers

CMD 40 and CMD 08 allow users who foot-propel to have an optimally configured, rigid, ultra-lightweight manual wheelchair for the best possible functional outcome. Pair this setup with a SmartDrive to easily and independently navigate your environment!

© 2023 Permobil. All rights reserved. Trademarks are identified by symbols ™ and ®. TiLite, the TiLite logo, Ti, TiFit, and The Titanium Experts are registered trademarks of TiLite, LLC. Bodypoint® is a registered trademark of Bodypoint Inc. The Natural-Fit® is a registered trademark of Three Rivers Holdings, LLC.