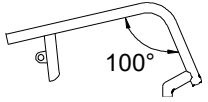
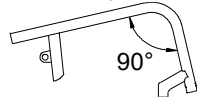
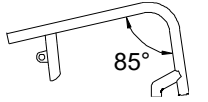

Permobil Limited Unit 7, Polaris Centre, 41 Brownfields, Welwyn Garden City, Herts, AL7 1AN United Kingdom - Phone: +44 1484 722888

Date .....	UK (English)	
User .....	Company stamp	Folding frame wheelchair
End user weight (kg) .....		<b>£ 4716,00</b>
Language user manual .....	Responsible .....	<b>Retail price - VAT not included</b>

Wheelchair measures	
<b>Keep attention to all measures.</b>	
EGO CUSTOM is a welded frame wheelchair, thus seat height and setting can not be modified after its manufacturing.	
Seat width (LS) <input type="checkbox"/> 33 <input type="checkbox"/> 36 <input type="checkbox"/> 39 <input type="checkbox"/> 42 <input type="checkbox"/> 45 <input type="checkbox"/> 48	
<small>The seat width is measured from the outer sides of the frame For seat enlargement see section enlargement of mudguard and armrest with integrated mudguard</small>	
Seat depth (PS) <input type="checkbox"/> 35 <input type="checkbox"/> 37,5 <input type="checkbox"/> 40 <input type="checkbox"/> 42,5 <input type="checkbox"/> 45 <input type="checkbox"/> 47,5	
<small>The real seat depth, from the front part of the seat cloth to the backrest tube will be 1,5 cm more than the declared one.</small>	
Footplate distance (DP) .....	(cm) ±0.5cm - adjustment steps 1.5cm
<small>(Real distance between seat and footplate) - IMPORTANT NOTICE! From the footplate to the floor minimum 4cm !! (Minimum Front height = DP + 4cm)</small>	
Setting	<input checked="" type="checkbox"/> Standard <input type="checkbox"/> Prudential <input type="checkbox"/> Active
Backrest Height (TS)	Std.Value 33,5 .....(min 26-max 47) adjustment steps 1.5cm
camber	<input checked="" type="checkbox"/> 0° <input type="checkbox"/> 2°
<b>Front height (min 44-max 52)</b>	.....
<b>Rear height (min 38-max 45)</b>	.....
<small>calculated with rear wheels 24"</small>	

<b>Front frame</b>		
Aluminium frame - welded made-to-measure		
<b>Footplate COMPACT, automatic Closure adjustable distance +/- 1,5cm</b>		
 <input type="checkbox"/>	 <input type="checkbox"/>	 <input type="checkbox"/>
(max 5" caster)	(max 5" caster)	(max 4" caster)

<b>Frame colour</b>			
<input checked="" type="checkbox"/> Bright silver	<input type="checkbox"/> Opaque black	<input type="checkbox"/> POLAR white	<input type="checkbox"/> Matt orange
<input type="checkbox"/> Tekno anthracite	<input type="checkbox"/> Matt Midnight blue	<input type="checkbox"/> Matt grey	<input type="checkbox"/> Matt red

<b>Backrest</b>
<input checked="" type="checkbox"/> Adjustable velcro straps and padded transpiring upholstery

<b>Handle tube</b>	
<input checked="" type="checkbox"/> Tubes with short handle	
<input type="checkbox"/> Tubes with standard handle	
<input type="checkbox"/> SPORT tubes Without push handles	<i>Lightest configuration</i>
<input type="radio"/> Folding handles	
<small>Not available with: Push handles for companion</small>	<b>02958      270,00</b>

<b>Casters</b>			
<input checked="" type="checkbox"/> 4" Soft			
<input type="checkbox"/> 3" Sport	<i>Lightest configuration</i>		
<input type="checkbox"/> 5" Soft			
<input type="radio"/> 3" Active Soft (wide)	(Aluminium alloy rim)	06824	<b>95,00</b>
<input type="radio"/> 4" Active Sport (narrow)	(Aluminium alloy rim)	01398	<b>95,00</b>
<input type="radio"/> 4" Active Soft (wide)	(Aluminium alloy rim)	03943	<b>95,00</b>
<input type="radio"/> 5" Active Soft (wide)	(Aluminium alloy rim)	07518	<b>95,00</b>
<input type="radio"/> 5" Pneumatic		10844	<b>68,00</b>

customer\_support\_uk@permobil.com - https://www.permobil.com/en-gb

Date .....	Order .....	User .....	Address .....
------------	-------------	------------	---------------

Special Options		
<input type="radio"/> lockingband/strip to close/fold the wheelchair	06833	25,00
<input type="radio"/> Drawstring to unlock the back with a singleaction	06834	135,00

Colour set: includes rear wheel hub and rim and front forks		
Only standard Progeo 22"/24" wheels have coloured hubs and rims		
☆ Black	22" 24" 25" 26"	
<input type="radio"/> Bright silver	22" 24"	00833 135,00
<input type="radio"/> Bright lime	22" 24"	00833 135,00
<input type="radio"/> Bright blue	22" 24"	00833 135,00
<input type="radio"/> Bright red	22" 24"	00833 135,00
<input type="radio"/> Bright fuchsia	22" 24"	00833 135,00
<input type="radio"/> POLAR white	22" 24"	00833 135,00
<input type="radio"/> Tekno anthracite	22" 24"	00833 135,00
<input type="radio"/> Matt Midnight blue	22" 24"	00833 135,00
<input type="radio"/> Matt grey	22" 24"	00833 135,00
<input type="radio"/> Matt red	22" 24"	00833 135,00

Rear wheels		
☆ 24" Ultra-light Progeo - Standard!		
<input type="checkbox"/> 22" Ultra-light Progeo - Standard!		
<input type="checkbox"/> 25" Ultra-light Progeo - Standard!	(colour: black)	
<input type="checkbox"/> 26" Progeo - Standard!	(colour: black)	
<input type="radio"/> 24" ULTRA-LIGHT PROGEO KEY SPORT	<i>Lightest configuration</i>	04383 695,00
<input type="radio"/> 24" Ultra-light "Spinergy LX"		01685 695,00
<input type="radio"/> 24" Ultra-light "Spinergy LXL"	<input type="checkbox"/> Black hub and white spokes <input type="checkbox"/> Hub and spokes black	07846 695,00
<input type="checkbox"/> 24" Ultra-light "Spinergy Flex rim"	Integrated aluminium/rubber handrim	02270 1.150,00
<input type="radio"/> 25" Ultra-light "Spinergy LX"		02101 695,00
<input type="radio"/> 25" Ultra-light "Spinergy LXL"	<input type="checkbox"/> Black hub and white spokes	07847 695,00
<input type="radio"/> 26" Ultra-light "Spinergy LX"		02102 695,00
<input type="radio"/> 24" Off-road (aluminium handrim black - Wheel distance 4cm)		01392 270,00

Rear wheel tyre		
☆ High pressure tyre	(22"-24"-25"-26")	<i>Lightest configuration</i>
<input type="checkbox"/> High pressure profile tyre	(24")	
<input type="radio"/> Marathon Plus	(24"-25")	with anti-puncture protection
<input type="radio"/> Anti-puncture - Colour Black	(24")	11083 95,00
<b>Not available with Rear wheels : 24" ULTRA-LIGHT PROGEO KEY SPORT, 24" Ultra-light "Spinergy LXL"</b>		
<input type="radio"/> Anti-puncture - Colour Grey	(22")	04181 105,00

Handrim	Wheel distance ☆ 3 cm	□ 4 cm		
☆ Aluminium	(22"-24"-25"-26")	<i>Lightest configuration</i>		
<input type="radio"/> Aluminium black SOFT-TOUCH	(24"-25")	(24" handrim, on 25" wheel is installed with spacers)	09170	160,00
<input type="radio"/> Chromed Steel	(24"-25")	(24" handrim, on 25" wheel is installed with spacers)	01684	160,00
<input type="radio"/> Titanium	(24"-25")	(24" handrim, on 25" wheel is installed with spacers)	00016	290,00
<input type="radio"/> Ultra Grepp	(24"-25")	(24" handrim, on 25" wheel is installed with spacers)	00017	290,00
<input type="radio"/> TOP FRICTION	(24"-25")	(24" handrim, on 25" wheel is installed with spacers)	11023	290,00
<b>Oval countour with a rubber insert</b>				
<input type="radio"/> NOVA H	(24"-25")	(24" handrim, on 25" wheel is installed with spacers)	11025	290,00
<b>Ergonomic black profile</b>				
<input type="radio"/> NOVA D	(24"-25")	(24" handrim, on 25" wheel is installed with spacers)	11026	290,00
<b>Ergonomic profile with rubber coating (ideal for quadriplegics)</b>				
<input type="radio"/> Silicon cover for standard aluminium handrim	Available for measures (22"- 24" - 26")		04050	172,00

customer\_support\_uk@permobil.com - https://www.permobil.com/en-gb

Date .....	Order .....	User .....	Address .....
------------	-------------	------------	---------------

### Wheel locks

- Bent lever push to lock
  - Straight lever push to lock
  - Straight lever pull to lock
  - Sport brake
  - Brake with extension lever push to lock
  - Brake with extension lever pull to lock
- 
- |  |       |        |
|--|-------|--------|
|  | 06428 | 135,00 |
|  | 01949 | 68,00  |
|  | 03372 | 68,00  |

### Automatic Closure footplate

- Footplate COMPACT, automatic Closure *Lightest configuration*
- Minimum footplate distance 35cm. **RAKE AND DEPTH ADJUSTABLE**
- Internal

External

11529

### Mudguard

- #### Mudguard - FIXED
- Carbon fibre mudguard
  - Carbon fibre Straight sideguard
- Mudguard enlargement**
- + 0 cm
  - + 1 cm  + 2 cm
- 
- |  |       |        |
|--|-------|--------|
|  | 12648 |        |
| <input type="checkbox"/> <b>Extra charge for : REMOVABLE VERSION</b> | 08921 | 135,00 |
- The distance between the two side guards is 1 cm wider than the seat width*

### Armrests

- Tubular armrests (Swing away, removable and height adjustable armrest)
- Exclude the installation OPTIONAL 1**
- 00694

270,00
- Removable armrest with integrated mudguard**
- Desk armrests PROGEO (Removable and height adjustable)
- Enlargement of Desk armrests PROGEO**
- + 0 cm
  - + 2 cm Available only with Ultra-light Progeo standard wheels and camber 0°
- 09956

240,00
- 09079

240,00
- The distance between the two side guards is 1 cm wider than the seat width*

### Accessories





- Pad for front frame protectors 07058 **56,00**
- Backrest-seat connection cloth 10241 **25,00**
- Removable storage bag (with quick coupling) 09811 **135,00**

Date .....	Order .....	User .....	Address .....
------------	-------------	------------	---------------

### Optional 1

**Important notice! With the EGO CUSTOM you may choose only one of these accessories with fee**

**Attention none of these accessories are available if have been chosen the Tubular armrests**

<input type="radio"/> Transit wheels			00836	158,00
<input type="radio"/> Anti-tipper with rapid hookup	(inside rotation to reduce the encumbrance) <input type="radio"/> Right <input type="radio"/> Left		00023 00024	145,00 145,00
<input type="radio"/> Tipping aid	<input type="radio"/> Right <input type="radio"/> Left		00025 01046	79,00 79,00
<input type="radio"/> Crutches support	<input type="radio"/> Right <input type="radio"/> Left		00838 00837	79,00 79,00

### Optional 2

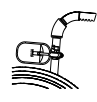
<input type="radio"/> Tetraclip	(Quick release axle for quadriplegic)		03947	189,00
<input type="radio"/> Safety pelvic belt			03972	68,00
<input type="radio"/> Harness			04103	145,00
<input type="radio"/> Push handles for companion	(Removable and height adjustable)		01048	203,00
<input type="radio"/> Lumbar support	(to insert in the backrest upholstery)		00013	43,00
<input type="radio"/> Swing away lateral support Prevents backrest folding	Not available with Posture backrest PHYSIO <input type="radio"/> Right <input type="radio"/> Left		02097 02098	270,00 270,00
<input type="radio"/> Spoke guards Black	(22"-24")		01043	158,00
<input type="radio"/> Spoke guards Transparent	(22"-24")		00835	158,00
<input type="radio"/> Spoke guards Progeo design	(22"-24")		00019	189,00

### Additional Kit

<input type="radio"/> 24" Off-road rear wheels	Off-Road tyre - aluminium handrim (black colour)		03378	534,00
<input type="radio"/> 24" FAT rear wheels	FAT tyre 3" - aluminium handrim (black colour)		09357	895,00

Date ..... Order ..... User ..... Address .....

### PHYSIO - Posture backrest (Std. Backrest upholstery not provided)

Removable with quick release  
Suitable for tubes with diameter 18+26mm  
Depth adjustment (4cm)  
Angle adjustment (±18°)

**AIR** Carbon shell  
not available for seat width 48

BACKREST HEIGHT	28	34	40	
Shell's shape 	Lateral retaining wing A=high - R=regular			
	A	R	A	R
	<input type="checkbox"/>	<input type="checkbox"/>	<input type="checkbox"/>	<input type="checkbox"/>

1.121,00

**POSTURE** Aluminum shell

BACKREST HEIGHT	34	40	52	
Shell's shape 	Lateral retaining wing R=regular			
	R	R	R	
	<input type="checkbox"/>	<input type="checkbox"/>	<input type="checkbox"/>	

1.085,00

### Configuration DEEP with side support PAD (height adjustable)

Alluminum lateral with padded, breathable upholstery.



Small (h 13cm)



Right 10272

49,00

Left 10272

49,00

Large (h 20cm)



Right 10273

49,00

Left 10273

49,00

### SWING AWAY - Lateral support

Fixing and adjustment hardware complete with protection sleeve  
Alluminum lateral with padded, breathable upholstery.

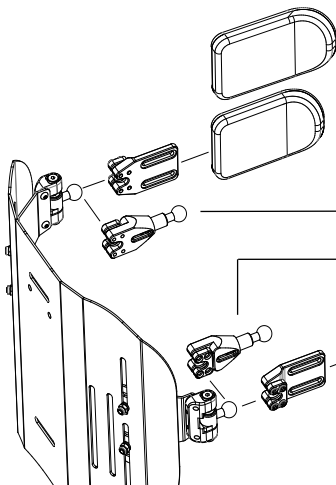

Large (18x12)

05647 196,00

Small (14x9)

05643 196,00

Lateral support extension

Quantity (number pcs).....

10271 74,00

Lateral support extension

Quantity (number pcs).....

Small (14x9)

05642 196,00

Large (18x12)

05646 196,00

Headrest adjustable - Double ball mounting system

Available only with backrest Physio Posture



Large (35x12,5)

05648 385,00

Small (25x12,5)

Permobil Limited Unit 7, Polaris Centre, 41 Brownfields, Welwyn Garden City, Herts, AL7 1AN United Kingdom - Phone: +44 1484 722888

customer\_support\_uk@permobil.com - https://www.permobil.com/en-gb

Date .....	Order .....	User .....	Address .....
------------	-------------	------------	---------------

### Note

Wheelchair : Progeo EGO CUSTOM - Rev. 2026.0	<b>Prices - VAT excluded</b> <small>to be added to the price list</small>	<table border="1" style="width: 100%; border-collapse: collapse;"> <tr> <th colspan="2" style="text-align: left; padding: 2px;">Send this page only if any optional have been chosen</th> </tr> <tr> <td style="padding: 2px;"><input type="checkbox"/> standard</td> <td style="padding: 2px;"><small>(supplied if no requests are indicated)</small></td> </tr> <tr> <td style="padding: 2px;"><input type="checkbox"/> on request</td> <td style="padding: 2px;"><small>(without extra charge)</small></td> </tr> <tr> <td style="padding: 2px;"><input type="checkbox"/> optional</td> <td style="padding: 2px;"><small>(cost to be added at the basic price)</small></td> </tr> </table>	Send this page only if any optional have been chosen		<input type="checkbox"/> standard	<small>(supplied if no requests are indicated)</small>	<input type="checkbox"/> on request	<small>(without extra charge)</small>	<input type="checkbox"/> optional	<small>(cost to be added at the basic price)</small>
Send this page only if any optional have been chosen										
<input type="checkbox"/> standard	<small>(supplied if no requests are indicated)</small>									
<input type="checkbox"/> on request	<small>(without extra charge)</small>									
<input type="checkbox"/> optional	<small>(cost to be added at the basic price)</small>									

### REFERENCE TABLES

1	Front height
	With closed frame (95°) max 5" caster With closed frame (90°) max 5" caster With closed frame (85°) max 4" caster
	The size of the fork will be defined only by Progeo in accordance with wheelchair final configuration.

2	Rear height			
	Rear wheels			
	22"	24"	25"	26"
min	35	min 38	min 39	min 40
max	43	max 45	max 46	max 48

3	Footplate option	Footplate distance
	Footplate COMPACT, automatic Closure	min 36
<b>IMPORTANT NOTICE! From the footplate to the floor minimum 4cm !! (Minimum Front height = DP + 4cm)</b> <b>NOTE! Lower footplate distances are possible only after our valuation</b> <b>Calculated with the best configuration and with the footplates positioned on inside.</b>		

4	Rear wheels	
Model	Features	
22" Ultra-light Progeo - Standard!	(not available in anthracite color)	
24" Ultra-light Progeo - Standard!	(available for all colours)	
24" ULTRA-LIGHT PROGEO KEY SPORT	(silver hub, black rim and 16 spokes)	
24" Ultra-light "Spinergy LX"	(silver hub, black rim and spokes)	
24" Ultra-light "Spinergy LXL"	(black hub and rim, 18 white spokes) - (black hub, rim and 18 spokes)	
24" Off-road	(colour: black) - (aluminium handrim - tyre Off-road)	
24" Ultra-light "Spinergy Flex rim"	(silver hub, black rim and spokes) - (integrated aluminium/rubber handrim - encumbrance reduction up to 3cm. - all tyre)	
25" Ultra-light "Spinergy LX"	(silver hub, black rim and spokes)	
25" Ultra-light "Spinergy LXL"	(black hub and rim, 18 white spokes)	
26" Progeo - Standard!	(colour: black)	
26" Ultra-light "Spinergy LX"	(silver hub, black rim and 18 spokes)	

Date	Order	User	Address
------	-------	------	---------

12" wheel - Motor 250W (750W maximum power)  
 14" wheel - Motor 1000W (1500W maximum power)

- Color display with switcher
- Maximum speed limit settable from display
- 5 speed levels selectable
- 10 display-selectable acceleration levels
- Adaptive Cruise Control
- Disc and electronic brake control lever
- Motor brake (adjustable in 10 levels from the display)
- Electronic brake with control bottom (adjustable in 10 levels from the display)
- Power regain when braking
- Error messages management from display (with error history)
- Rear gear beeper
- 48V - 5.8 Ah battery Autonomy up to 25km
- 48V - 11.6 Ah Power plus battery Autonomy up to 50km
- Battery charger 48V
- Rear gear
- USB port
- Easle
- Mudguard
- Front spoiler with predisposition for FULL LED light

**(Certified software)**

Mototronik

10979 N/A



### Handlebar

☆ STANDARD controls

☆ Thumb accelerator

☆ Right  
12592

Left  
12593

Grip throttle

Right  
10913

Left  
10914

Disc and electronic brake control lever

☆ Right  
12594

Left  
12595

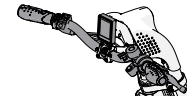

QUADRIPLEGIC controls  
 Handlebar PUSH&PULL



10905 428,00

42,00

☆ MOTOTRONIK 12" wheel

Motor 250W (750W maximum power)  
 Maximum speed according to law

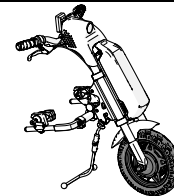

MOTOTRONIK 14" wheel

Motor 1000W (1500W maximum power)  
 Maximum speed according to law

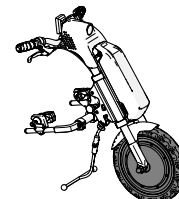

10903 428,00

### Battery





☆ 48V - 5.8 Ah battery *Autonomy up to 25 km*

48V - 11.6 Ah Power plus battery *Autonomy up to 50 km*

10904 289,00

Date ..... Order ..... User ..... Address .....

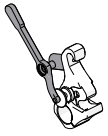
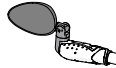
### Accessories

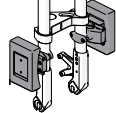
- |   |   |   |        |        |
|---|---|---|--------|--------|
| <input type="radio"/> FULL LED light (high intensity)<br>Integrated in the spoiler  |  | 10908   | 107,00 |        |
| <input type="radio"/> Handlebar extension<br>Adjustable from 15cm up to 23cm  |  | 10907   | 182,00 |        |
| <input type="radio"/> Motor unit facilitated unlock lever<br>Recommended with handlebar for quadriplegic  |  | 10915   | 82,00  |        |
| <input type="radio"/> Additional FLY 48V - 2.9 Ah battery<br>Autonomy up to 15km<br>Approved for air transport  |   | 10906   | 697,00 |        |
| <input type="radio"/> Rearview mirror   | <input type="radio"/> Right<br><input type="radio"/> Left                           |    | 10909  | 32,00  |
| <input type="radio"/> Basket (removable) - (with KLICKfix® attachment system)   |   |   | 10912  | 212,00 |
| <input type="radio"/> Removable front weight - (with KLICKfix® attachment system)<br>(it increases the weight over the power wheel to improve traction) |   |  | 10910  | 311,00 |
| <input type="radio"/> Travel bag  |   |   | 10916  | 155,00 |

### Note

Wheelchair : Progeo EGO CUSTOM - Rev. 2026.0

Prices - VAT excluded  
to be added to the price list

Send this page only if any optional have been chosen

- |                                     |            |   |
|-------------------------------------|------------|---|
| <input checked="" type="checkbox"/> | standard   | (supplied if no requests are indicated) |
| <input type="checkbox"/>            | on request | (without extra charge)                  |
| <input type="radio"/>               | optional   | (cost to be added at the basic price)   |