

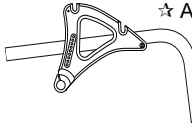

permobil Order Form - Progeo JOKER

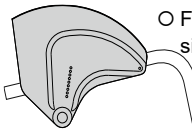

Permobil Limited Unit 7, Polaris Centre, 41 Brownfields, Welwyn Garden City, Herts, AL7 1AN United Kingdom - Phone: +44 1484 722888

Date	UK (English)	
User	Company stamp	Rigid frame wheelchair CRASH TEST APPROVED
End user weight (kg)		£ 2592,00
Language user manual	Responsible	Retail price - VAT not included

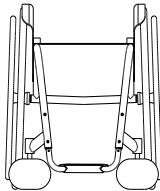
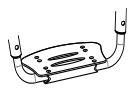
Wheelchair measures - The tolerance on all the dimensions indicated and/or required is ± 10 mm			
Seat width (LS)	<input type="checkbox"/> 33	<input type="checkbox"/> 36	<input type="checkbox"/> 39
	<input type="checkbox"/> 42	<input type="checkbox"/> 45	<input type="checkbox"/> 48
The seat width is measured from the outer sides of the frame			
Seat depth (PS)	<input type="checkbox"/> 35	<input type="checkbox"/> 37,5	<input type="checkbox"/> 40
	<input type="checkbox"/> 42,5	<input type="checkbox"/> 45	<input type="checkbox"/> 47,5
	<input type="checkbox"/> 50		
The real seat depth, from the front part of the seat cloth to the backrest tube will be 1,5 cm more than the declared one.			
Footplate distance (DP) (cm) ±0.5cm - adjustment steps 1.5cm		
(Real distance between seat and footplate) - IMPORTANT NOTICE! From the footplate to the floor minimum 4cm !! (Minimum Front height = DP + 4cm)			
Setting	<input checked="" type="checkbox"/> Standard	<input type="checkbox"/> Prudential	<input type="checkbox"/> Active
		<input type="checkbox"/> Extreme	
Backrest Height (TS)	Std. Value 33,5(min 26-max 47) adjustment steps 1.5cm		
camber	<input checked="" type="checkbox"/> 0°	<input type="checkbox"/> 2°	<input type="checkbox"/> 4°
Front height STD 49	Rear height STD 42

	☆ Aluminum rear adjustment plate ☆ Removable mudguard ABS <input type="checkbox"/> Removable ABS fibre straight sideguard <input type="radio"/> Removable carbon fibre mudguard <input type="radio"/> Removable Carbon fibre straight sideguard	03946 337,00 08918 337,00
	<input type="radio"/> FULL CARBON rear adjustment plate with integrated sideguard ☆ Version mudguard (Available only with rear wheels 24")	07646 1.006,00

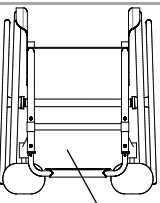
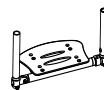
JOKER		☆ Aluminium footplate, rake adjustable Minimum footplate distance 35cm. ☆ Internal <input type="checkbox"/> 2/3 Internal <input type="checkbox"/> External <input type="checkbox"/> 2/3 External	11523
		<input type="radio"/> Aluminium footplate EVOLUTION - rake and depth adjustable Minimum footplate distance 35cm. ☆ Internal <input type="checkbox"/> 2/3 Internal <input type="checkbox"/> External <input type="checkbox"/> 2/3 External	07649 145,00
		<input type="radio"/> One piece Carbon fibre footplate, rake adjustable Minimum footplate distance 35cm. ☆ Internal <input type="checkbox"/> External	03346 319,00

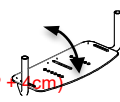
JOKER ZERO		<input type="radio"/> Plastic footrest, rake adjustable Minimum footplate distance 15cm. ☆ 2/3 Internal <input type="checkbox"/> 2/3 External	06814 203,00
		<input type="radio"/> One piece aluminium footplate - Flip-up!, rake and depth adjustable Minimum footplate distance 15cm. ☆ Internal <input type="checkbox"/> 2/3 Internal <input type="checkbox"/> External <input type="checkbox"/> 2/3 External	06856 203,00
		<input type="radio"/> One piece Carbon fibre footplate rake adjustable, swing away, flip-up. Minimum footplate distance 15cm. ☆ Internal <input type="checkbox"/> External	06857 522,00
		<input type="radio"/> One piece aluminium footplate - Flip-up! FLIP-BACK! - rake and depth adjustable WITHOUT rigidizer bar (max 5" caster) IMPORTANT NOTICE! From the footplate to the floor minimum 6cm !! (Minimum Front height = DP + 4cm) With 5" front wheel the difference between Front Height and Rear Height must be greater than 5cm	09420 203,00

Date Order User Address

Front frame

☆ Aluminium standard frame

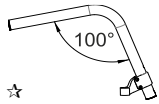

☆

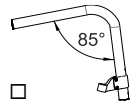
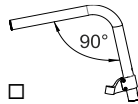

(max 4" caster)

Frame colour

Frame colour (without extra charge)

- ☆ Opaque black POLAR white
- Tekno anthracite Matt Midnight blue Matt orange Matt grey Matt red

Frame colour on request

- Bright silver Bright fuchsia Bright blue china 12579 **109,00**
- Bright blue Bright lime Bright red

Seat

- ☆ Seat cloth with pocket (under seat)
- Seat with tension straps 08883 **240,00**
- Carbon rigid seat 08336 **509,00**
- Pocket (under seat) [25x11x4,5] 08281 **79,00**

Rear wheels axle

- ☆ Aluminum rear wheels axle
- Carbon fiber rear wheels axle *Lightest configuration* 07647 **158,00**

Backrest adjustment and fixing system

- ☆ Backrest with double locking (upright and folded) with rake adjustable from -4° to +16°
- Backrest with upright locking system ONLY (no locking when folded) with rake adjustable from -4° to +16°
- Fixed back(non-folding back) with rake adjustable from -4° to +16°

Backrest

- ☆ Adjustable velcro straps and padded transpiring upholstery
- ☆ Aluminium backrest 06811 **203,00**
- Titanium backrest 04389 **802,00**
- Carbon fibre backrest 04389 **802,00**

- AIR** Integrated posture backrest (NOT REMOVABLE) **1.121,00**
- Carbon shell - Lateral retaining 7,5cm
Depth adjustment ±1cm. - Angle adjustment ±10°
not available for seat width 48

H 28	H 34	H 40
Backrest Height (TS) min 34 (.....)	Backrest Height (TS) min 38 (.....)	Backrest Height (TS) min 44 (.....)
Lateral retaining wing A=high - R=regular		
A	R	A
A	R	A
A	R	A
A	R	A
<input type="checkbox"/>	<input type="checkbox"/>	<input type="checkbox"/>

Installation on:

- ☆ Backrest tubes
- Aluminium backrest
- Titanium backrest 06811 **203,00**
- Carbon fibre backrest 04389 **802,00**

Date	Order	User	Address
------------	-------------	------------	---------------

Handle tube			
☆ Tubes with standard handle			
<input type="checkbox"/> Tubes with short handle			
<input type="checkbox"/> SPORT tubes Without push handles			
<input type="radio"/> Carbon fibre tubes with short handle	<i>Lightest configuration</i>	04390	158,00
Not available with: Posture backrest PHYSIO - Posture backrest A I R			
<input type="radio"/> Folding handles	Minimum backrest height 30,5cm	02958	270,00
Not available with: Push handles for companion			



Casters			
☆ 4" Soft			
<input type="checkbox"/> 3" Sport <i>Lightest configuration</i>			
<input type="checkbox"/> 5" Soft			
<input type="checkbox"/> 6" Soft (Available only with 100° angle)			
<input type="checkbox"/> 6" Pneumatic (Available only with 100° angle)			
<input type="radio"/> 3" Active Soft (wide)	(Aluminium alloy rim)	06824	95,00
<input type="radio"/> 4" Active Sport (narrow)	(Aluminium alloy rim)	01398	95,00
<input type="radio"/> 4" Active Soft (wide)	(Aluminium alloy rim)	03943	95,00
<input type="radio"/> 5" Active Soft (wide)	(Aluminium alloy rim)	07518	95,00
<input type="radio"/> 5" Pneumatic		10844	68,00

Colour set: includes rear wheel hub and rim and front forks			
Only standard Progeo 22"/24" wheels have coloured hubs and rims			
☆ Black	22" 24" 25" 26"		
<input type="radio"/> Bright silver	22" 24"	00833	135,00
<input type="radio"/> Bright lime	22" 24"	00833	135,00
<input type="radio"/> Bright blue	22" 24"	00833	135,00
<input type="radio"/> Bright red	22" 24"	00833	135,00
<input type="radio"/> Bright fuchsia	22" 24"	00833	135,00
<input type="radio"/> POLAR white	22" 24"	00833	135,00
<input type="radio"/> Tekno anthracite	22" 24"	00833	135,00
<input type="radio"/> Matt Midnight blue	22" 24"	00833	135,00
<input type="radio"/> Matt grey	22" 24"	00833	135,00
<input type="radio"/> Matt red	22" 24"	00833	135,00

Rear wheels			
☆ 24" Ultra-light Progeo - Standard!			
<input type="checkbox"/> 22" Ultra-light Progeo - Standard!			
<input type="checkbox"/> 25" Ultra-light Progeo - Standard!	(colour: black)		
<input type="checkbox"/> 26" Progeo - Standard!	(colour: black)		
<input type="radio"/> 24" ULTRA-LIGHT PROGEO KEY SPORT	<i>Lightest configuration</i>	04383	695,00
<input type="radio"/> 24" Ultra-light "Spinergy LX"		01685	695,00
<input type="radio"/> 24" Ultra-light "Spinergy LXL"	<input type="checkbox"/> Black hub and white spokes <input type="checkbox"/> Hub and spokes black	07846	695,00
<input type="radio"/> 24" Ultra-light "Spinergy Flex rim"	Integrated aluminium/rubber handrim	02270	1.150,00
<input type="radio"/> 25" Ultra-light "Spinergy LX"		02101	695,00
<input type="radio"/> 25" Ultra-light "Spinergy LXL"	<input type="checkbox"/> Black hub and white spokes	07847	695,00
<input type="radio"/> 26" Ultra-light "Spinergy LX"		02102	695,00
<input type="radio"/> 24" Off-road (aluminium handrim black - Wheel distance 4cm)		01392	270,00

Rear wheel tyre			
☆ High pressure tyre	(22"-24"-25"-26")	<i>Lightest configuration</i>	
<input type="checkbox"/> High pressure profile tyre	(24")		
<input type="radio"/> Marathon Plus	(24"-25")	with anti-puncture protection	01669 95,00
<input type="radio"/> Anti-puncture - Colour Grey	(22")		04181 105,00
<input type="radio"/> Anti-puncture - Colour Black	(24")		11083 95,00
Not available with Rear wheels : 24" ULTRA-LIGHT PROGEO KEY SPORT, 24" Ultra-light "Spinergy LXL"			

Handrim			
		Wheel distance ☆ 3 cm	<input type="checkbox"/> 4 cm
☆ Aluminium	(22"-24"-25"-26")	<i>Lightest configuration</i>	
<input type="radio"/> Aluminium black SOFT-TOUCH	(24"-25")	(24" handrim, on 25" wheel is installed with spacers)	09170 160,00
<input type="radio"/> Chromed Steel	(24"-25")	(24" handrim, on 25" wheel is installed with spacers)	01684 160,00
<input type="radio"/> Titanium	(24"-25")	(24" handrim, on 25" wheel is installed with spacers)	00016 290,00
<input type="radio"/> Ultra Grepp	(24"-25")	(24" handrim, on 25" wheel is installed with spacers)	00017 290,00
<input type="radio"/> TOP FRICTION	(24"-25")	(24" handrim, on 25" wheel is installed with spacers)	11023 290,00
Oval countour with a rubber insert			
<input type="radio"/> NOVA H	(24"-25")	(24" handrim, on 25" wheel is installed with spacers)	11025 290,00
Ergonomic black profile			
<input type="radio"/> NOVA D	(24"-25")	(24" handrim, on 25" wheel is installed with spacers)	11026 290,00
Ergonomic profile with rubber coating (ideal for quadriplegics)			
<input type="radio"/> Silicon cover for standard aluminium handrim		Available for measures (22"- 24" - 26")	04050 172,00

Permobil Limited Unit 7, Polaris Centre, 41 Brownfields, Welwyn Garden City, Herts, AL7 1AN United Kingdom - Phone: +44 1484 722888

customer_support_uk@permobil.com - https://www.permobil.com/en-gb

Date Order User Address

Wheel locks

Bent lever push to lock

- Straight lever push to lock
 Straight lever pull to lock

Sport brake *Lightest configuration*

- Brake with extension lever push to lock
 Brake with extension lever pull to lock

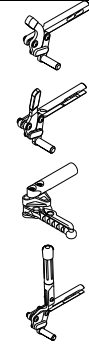

06428 **135,00**
 01949 **68,00**
 03372 **68,00**

Armrests

Tubular armrests (Swing away, removable and height adjustable armrest)



00694 **270,00**

Accessories

- Pad for front frame protectors
 Backrest-seat connection cloth
 Removable storage bag (with quick coupling)

07058 **56,00**
 10241 **25,00**
 09811 **135,00**

SAFETY

- 4 points tie-down system rings
 (installation must be carried out by the manufacturer)
 A head restraint suitable for transportation must be available and fitted accordingly during transportation.



08654 **203,00**

Optional 1

Only one optional devices for side can be chosen

Transit wheels Exclude the installation of Anti-tippers



03290 **158,00**

Anti-tippers - Easy Swing Away - (Non removable) - Exclude the installation of Transit wheels

Rotatable and lockable 90°

It is possible to install anti-tipping on one side only

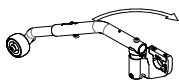

- Right **13162 145,00**
 Left **13163 145,00**

Rotatable and lockable 90° - 180°

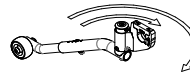

- Right **13164 145,00**
 Left **13165 145,00**

Anti-tipper with rapid hookup
 (inside rotation to reduce the encumbrance) Exclude the installation of Transit wheels

- Right
 Left



06821 **145,00**
 06822 **145,00**

Optional 2

Push handles for companion (Removable and height adjustable)



03645 **189,00**

Tetraclip (Quick release axle for quadriplegic)

03947 **189,00**

- Safety pelvic belt
 Harness

03972 **68,00**
 04103 **145,00**

Lumbar support (to insert in the backrest upholstery)

00013 **43,00**

Swing away lateral support Prevents backrest folding
 Not available with Posture backrest PHYSIO - Posture backrest A I R

- Right
 Left

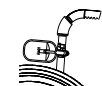

02097 **270,00**
 02098 **270,00**

- Spoke guards Black (22"-24")
 Spoke guards Transparent (22"-24")
 Spoke guards Progeo design (22"-24")

01043 **158,00**
 00835 **158,00**
 00019 **189,00**

Additional Kit

- 24" Off-road rear wheels Off-Road tyre - aluminium handrim (black colour)
 24" FAT rear wheels FAT tyre 3" - aluminium handrim (black colour)





03378 **534,00**
 09357 **895,00**

Date Order User Address

PHYSIO - Posture backrest (Std. Backrest upholstery not provided)

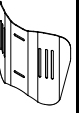
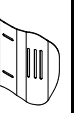

Removable with quick release
Suitable for tubes with diameter 18+26mm
Depth adjustment (4cm)
Angle adjustment (±18°)

- AIR** Carbon shell
not available for seat width 48

BACKREST HEIGHT	28	34	40			
Shell's shape 	Lateral retaining wing A=high - R=regular					
	A	R	A	R	A	R
						
	<input type="checkbox"/>	<input type="checkbox"/>	<input type="checkbox"/>	<input type="checkbox"/>	<input type="checkbox"/>	<input type="checkbox"/>

1.121,00

- POSTURE** Aluminum shell

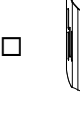
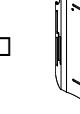
BACKREST HEIGHT	34	40	52			
Shell's shape 	Lateral retaining wing R=regular					
	R	R	R			
						
	<input type="checkbox"/>	<input type="checkbox"/>	<input type="checkbox"/>			

1.085,00

Configuration DEEP with side support PAD (height adjustable)

Alluminum lateral with padded, breathable upholstery.



Small (h 13cm)



- Right 10272

49,00

- Left 10272

49,00

Large (h 20cm)



- Right 10273

49,00

- Left 10273

49,00

SWING AWAY - Lateral support

Fixing and adjustment hardware complete with protection sleeve
Alluminum lateral with padded, breathable upholstery.

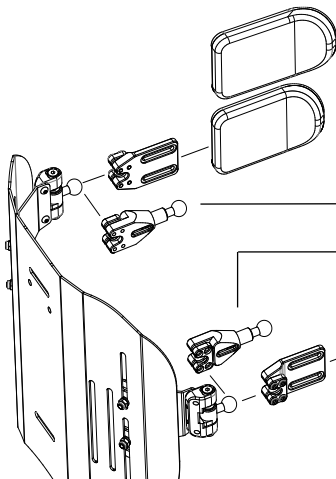

- Large (18x12)

05647 196,00

- Small (14x9)

05643 196,00

- Lateral support extension

Quantity (number pcs) (.....)

10271 74,00

- Lateral support extension

Quantity (number pcs) (.....)

- Small (14x9)

05642 196,00

- Large (18x12)

05646 196,00

- Headrest adjustable - Double ball mounting system



Available only with backrest Physio Posture



- Large (35x12,5)
- Small (25x12,5)

05648 385,00

REFERENCE TABLES

1		Front height			
		With closed frame (95°) max 5" caster			
		With closed frame (90°) max 5" caster			
		With closed frame (85°) max 4" caster			
FORK		Casters			
		3"	4"	5"	6"
SPORT		max 52	max 53	max 54	
SMALL		max 54	max 55	max 56	max 57
MEDIUM		max 56	max 57	max 58	max 59

The size of the fork will be defined only by Progeo in accordance with wheelchair final configuration.

2		Rear height			
		Rear wheels			
		22"	24"	25"	26"
min	36	min	38	min	39
max	44	min	46	max	47
		min	47	max	48

3	Footplate option	Footplate distance
	Aluminium footplate rake adjustable	min 35
	One piece Carbon fibre footplate	min 35
	One piece Carbon fibre footplate rake adjustable	min 35
	Plastic footrest, rake adjustable	min 35
	One piece aluminium footplate - Flip-up!, rake and depth adjustable	min 35
	One piece Carbon fibre footplate rake adjustable, swing away, flip-up.	min 35
IMPORTANT NOTICE! From the footplate to the floor minimum 4cm !! (Minimum Front height = DP + 4cm)		
Calculated with the best configuration and with the footplates positioned on inside.		
NOTE! Lower footplate distances are possible only after our valuation		

4	Rear wheels	
	Model	Features
	22" Ultra-light Progeo - Standard!	(not available in anthracite color)
	24" Ultra-light Progeo - Standard!	(available for all colours)
	24" ULTRA-LIGHT PROGEO KEY SPORT	(silver hub, black rim and 16 spokes)
	24" Ultra-light "Spinergy LX"	(silver hub, black rim and spokes)
	24" Ultra-light "Spinergy LXL"	(black hub and rim, 18 white spokes) - (black hub, rim and 18 spokes)
	24" Ultra-light "Spinergy Flex rim"	(silver hub, black rim and spokes) - (integrated aluminium/rubber handrim - encumbrance reduction up to 3cm. - all tyre)
	24" Off-road	(colour: black) - (aluminium handrim - tyre Off-road)
	25" Ultra-light "Spinergy LX"	(silver hub, black rim and spokes)
	25" Ultra-light "Spinergy LXL"	(black hub and rim, 18 white spokes)
	26" Progeo - Standard!	(colour: black)
	26" Ultra-light "Spinergy LX"	(silver hub, black rim and 18 spokes)

Wheelchair : Progeo JOKER - Rev. 2026.0

Date	Order	User	Address
------	-------	------	---------

12" wheel - Motor 250W (750W maximum power)
 14" wheel - Motor 1000W (1500W maximum power)

- Color display with switcher
- Maximum speed limit settable from display
- 5 speed levels selectable
- 10 display-selectable acceleration levels
- Adaptive Cruise Control
- Disc and electronic brake control lever
- Motor brake (adjustable in 10 levels from the display)
- Electronic brake with control bottom (adjustable in 10 levels from the display)
- Power regain when braking
- Error messages management from display (with error history)
- Rear gear beeper
- 48V - 5.8 Ah battery Autonomy up to 25km
- 48V - 11.6 Ah Power plus battery Autonomy up to 50km
- Battery charger 48V
- Rear gear
- USB port
- Easle
- Mudguard
- Front spoiler with predisposition for FULL LED light

(Certified software)

Mototronik

10979 N/A



Handlebar

☆ STANDARD controls

☆ Thumb accelerator

☆ Right
12592

Left
12593

Grip throttle

Right
10913

Left
10914

Disc and electronic brake control lever

☆ Right
12594

Left
12595

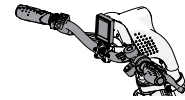

42,00

QUADRIPLEGIC controls
 Handlebar PUSH&PULL

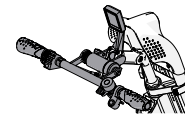

10905 428,00

☆ MOTOTRONIK 12" wheel

Motor 250W (750W maximum power)
 Maximum speed according to law

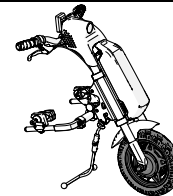

MOTOTRONIK 14" wheel

Motor 1000W (1500W maximum power)
 Maximum speed according to law

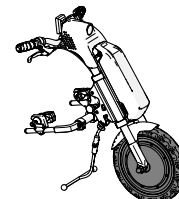

10903 428,00

Battery

☆ 48V - 5.8 Ah battery

Autonomy up to 25 km





48V - 11.6 Ah Power plus battery

Autonomy up to 50 km

10904 289,00

Date Order User Address

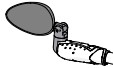
Accessories

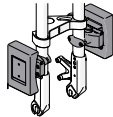
- | | | | | |
|---|---|---|--------|--------|
| <input type="radio"/> FULL LED light (high intensity)
Integrated in the spoiler |  | 10908 | 107,00 | |
| <input type="radio"/> Handlebar extension
Adjustable from 15cm up to 23cm |  | 10907 | 182,00 | |
| <input type="radio"/> Motor unit facilitated unlock lever
Recommended with handlebar for quadriplegic |  | 10915 | 82,00 | |
| <input type="radio"/> Additional FLY 48V - 2.9 Ah battery
Autonomy up to 15km
Approved for air transport | | 10906 | 697,00 | |
| <input type="radio"/> Rearview mirror | <input type="radio"/> Right
<input type="radio"/> Left |  | 10909 | 32,00 |
| | | | 10909 | 32,00 |
| <input type="radio"/> Basket (removable) - (with KLICKfix® attachment system) | |  | 10912 | 212,00 |
| <input type="radio"/> Removable front weight - (with KLICKfix® attachment system)
(it increases the weight over the power wheel to improve traction) | |  | 10910 | 311,00 |
| <input type="radio"/> Travel bag | | | 10916 | 155,00 |

Permobil Limited Unit 7, Polaris Centre, 41 Brownfields, Welwyn Garden City, Herts, AL7 1AN United Kingdom - Phone: +44 1484 722888

customer_support_uk@permobil.com - https://www.permobil.com/en-gb

Note

Send this page only if any optional have been chosen

- | | | |
|-------------------------------------|------------|---|
| <input checked="" type="checkbox"/> | standard | (supplied if no requests are indicated) |
| <input type="checkbox"/> | on request | (without extra charge) |
| <input type="radio"/> | optional | (cost to be added at the basic price) |

Wheelchair : Progeo JOKER - Rev. 2026.0

Prices - VAT excluded
to be added to the price list