

Date	UK (English)	
User	Company stamp	
End user weight (kg)		Rigid frame wheelchair
Language user manual	Responsible	£ 3650,00
		Retail price - VAT not included

Keep attention to all measures.

JOKER ENERGY is a completely welded wheelchair and no modifications can be carried out after its manufacturing.

Wheelchair measures

Seat width (LS)	<input type="checkbox"/> 33	<input type="checkbox"/> 36	<input type="checkbox"/> 39	<input type="checkbox"/> 42	<input type="checkbox"/> 45	<input type="checkbox"/> 48
-----------------	-----------------------------	-----------------------------	-----------------------------	-----------------------------	-----------------------------	-----------------------------

The seat width is measured from the outer sides of the frame
For seat enlargement see section enlargement of mudguard

Seat depth (PS)	<input type="checkbox"/> 35	<input type="checkbox"/> 37,5	<input type="checkbox"/> 40	<input type="checkbox"/> 42,5	<input type="checkbox"/> 45	<input type="checkbox"/> 47,5	<input type="checkbox"/> 50
-----------------	-----------------------------	-------------------------------	-----------------------------	-------------------------------	-----------------------------	-------------------------------	-----------------------------

The real seat depth, from the front part of the seat cloth to the backrest tube will be 1,5 cm more than the declared one.

Footplate distance (DP) (cm)
(Real distance between seat and footplate) - IMPORTANT NOTICE! From the footplate to the floor minimum 4cm !! (Minimum Front height = DP + 4cm)

Setting ☆ Standard Extremely prudenti Prudential Active Extreme

Backrest Height (TS) Std.Value 33,5 (min 26-max 47) adjustment steps 1.5cm

Rear wheel camber ☆ 2° 0° 4° 8° 12° **Special cambers (00989 - 135£)**
See reference tables N°4

Front height STD 49	Rear height STD 42
---------------------------	--------------------------

Frame

☆ Made-to-measure aluminium welded frame
Backrest with rake adjustable from -4° to +16°

Made-to-measure aluminium welded frame with fixed and welded backrest **08932 802,00**
Not available: bright silver!!

☆ 0° (90° to the floor)

90° to the seat

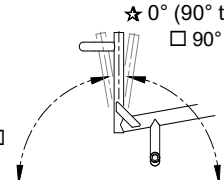

(.....) to the ground

(.....) to the ground

Frame Angle

☆ Frame Angle STD 95° Frame Angle :

Frame Angle 90° to the floor
Exclude the installation of casters 5"

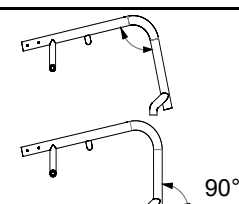

Frame's depth

Front frame extension

☆ 0 cm	<input type="checkbox"/> 0,5 cm	<input type="checkbox"/> 1 cm	<input type="checkbox"/> 1,5 cm	<input type="checkbox"/> 2 cm	<input type="checkbox"/> 2,5 cm
	<input type="checkbox"/> 3 cm	<input type="checkbox"/> 3,5 cm	<input type="checkbox"/> 4 cm	<input type="checkbox"/> 4,5 cm	<input type="checkbox"/> 5 cm

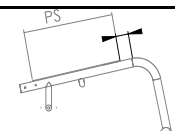

Footplate

☆ Tubular aluminium footplate - WELDED, not adjustable in height and angle



with plastic plate **with carbon fiber plate**
09193 135,00

Aluminium footplate EVOLUTION - (adjustable distance +/- 1,5cm)
rake and depth adjustable

☆ Internal 2/3 Internal 2/3 External External

One piece Carbon fibre footplate - (adjustable distance +/- 1,5cm)
Rake adjustable

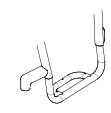
☆ Internal External

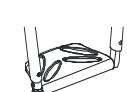
04456 270,00

04111 466,00

Date	Order	User	Address
------------	-------------	------------	---------------

Frame colour (without extra charge)

☆ Bright silver (Not available with welded backrest)

<input type="checkbox"/> POLAR white	<input type="checkbox"/> Opaque black	<input type="checkbox"/> Matt orange
<input type="checkbox"/> Tekno anthracite	<input type="checkbox"/> Matt Midnight blue	<input type="checkbox"/> Matt red
		<input type="checkbox"/> Matt grey

Seat

☆ Seat cloth with pocket (under seat)

<input type="radio"/> Seat with tension straps	08883	240,00
<input type="radio"/> Carbon rigid seat	08336	509,00
<input type="radio"/> Pocket (under seat) [25x11x4,5]	08281	79,00

Backrest adjustment and fixing system - Not available with welded backrest



☆ Backrest with double locking (upright and folded) **with rake adjustable from -4° to +16°**

Backrest with upright locking system ONLY (no locking when folded) **with rake adjustable from -4° to +16°**

Fixed back(non-folding back) **with rake adjustable from -4° to +16°**

Backrest

☆ Adjustable velcro straps and padded transpiring upholstery

☆ Aluminium backrest ○ Titanium backrest Not available with welded backrest ○ Carbon fibre backrest Not available with welded backrest	  	13599 203,00 04389 802,00
--	--	--

AIR **Integrated posture backrest (NOT REMOVABLE)** 1.121,00

Carbon shell - Lateral retaining 7,5cm
 Depth adjustment ±1cm. - Angle adjustment ±10°
 not available for seat width 48

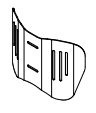
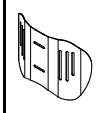
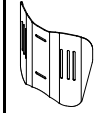
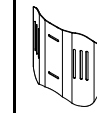
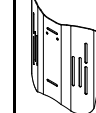
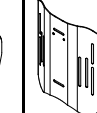
H 28	H 34	H 40			
Backrest Height (TS) min 34	Backrest Height (TS) min 38	Backrest Height (TS) min 44			
(.....)	(.....)	(.....)			
Lateral retaining wing A=high - R=regular					
A	R	A	R	A	R
					
<input type="checkbox"/>	<input type="checkbox"/>	<input type="checkbox"/>	<input type="checkbox"/>	<input type="checkbox"/>	<input type="checkbox"/>





Installation on:

☆ Aluminium backrest tubes
 WITHOUT backrest rigidizer

Aluminium backrest

Titanium backrest
 Not available with welded backrest

Carbon fibre backrest
 Not available with welded backrest

	   	13599 203,00 04389 802,00
--	--	--

Handle tube

☆ Tubes with short handle

Tubes with standard handle

SPORT tubes Without push handles

Carbon fibre tubes with short handle *Lightest configuration* 04390 **158,00**

Not available with: Posture backrest PHYSIO - Posture backrest A I R

Folding handles **Minimum backrest height 30,5cm** 13598 **270,00**

Not available with: Push handles for companion

Colour set: includes rear wheel hub and rim and front forks

Only standard Progeo 22"/24" wheels have coloured hubs and rims

☆ Black	22" 24" 25" 26"		
○ Bright silver	22" 24"	08833	135,00
○ Bright lime	22" 24"	08833	135,00
○ Bright blue	22" 24"	08833	135,00
○ Bright red	22" 24"	08833	135,00
○ Bright fuchsia	22" 24"	08833	135,00
○ POLAR white	22" 24"	08833	135,00
○ Tekno anthracite	22" 24"	08833	135,00
○ Matt Midnight blue	22" 24"	08833	135,00
○ Matt grey	22" 24"	08833	135,00
○ Matt red	22" 24"	08833	135,00







Date	Order	User	Address
------------	-------------	------------	---------------

Casters			
<input checked="" type="checkbox"/> 4" Soft			
<input type="checkbox"/> 3" Sport		<i>Lightest configuration</i>	
<input type="checkbox"/> 5" Soft		Not available with frame angle 90° to the floor	
<input type="checkbox"/> 3" Active Soft (wide) - Aluminium alloy rim			13592 95,00
<input type="checkbox"/> 4" Active Sport (narrow) - Aluminium alloy rim			13593 95,00
<input type="checkbox"/> 4" Active Soft (wide) - Aluminium alloy rim			13594 95,00
<input type="checkbox"/> 5" Active Soft (wide) - Aluminium alloy rim		Not available with frame angle 90° to the floor	13595 95,00
<input type="checkbox"/> 5" Pneumatic		Not available with frame angle 90° to the floor	13596 68,00

Rear wheels			
☆ 24" Ultra-light Progeo - Standard!			
<input type="checkbox"/> 22" Ultra-light Progeo - Standard!			
<input type="checkbox"/> 25" Ultra-light Progeo - Standard!	(colour: black)		
<input type="checkbox"/> 26" Progeo - Standard!	(colour: black)		
<input type="checkbox"/> 24" ULTRA-LIGHT PROGEO KEY SPORT	<i>Lightest configuration</i>		13585 695,00
<input type="checkbox"/> 24" Ultra-light "Spinergy LX"			13586 695,00
<input type="checkbox"/> 24" Ultra-light "Spinergy LXL"	<input type="checkbox"/> Black hub and white spokes	<input type="checkbox"/> Hub and spokes black	13587 695,00
<input type="checkbox"/> 24" Ultra-light "Spinergy Flex rim"	Integrated aluminium/rubber handrim		02270 1.150,00
<input type="checkbox"/> 25" Ultra-light "Spinergy LX"			13588 695,00
<input type="checkbox"/> 25" Ultra-light "Spinergy LXL"	<input type="checkbox"/> Black hub and white spokes		13589 695,00
<input type="checkbox"/> 26" Ultra-light "Spinergy LX"			13590 695,00
<input type="checkbox"/> 24" Off-road (aluminium handrim black - Wheel distance 4cm)			01392 270,00

Rear wheel tyre			
☆ High pressure tyre	(22"-24"-25"-26")	<i>Lightest configuration</i>	
<input type="checkbox"/> High pressure profile tyre	(24")		
<input type="checkbox"/> Marathon Plus	(24"-25")	with anti-puncture protection	01669 95,00
<input type="checkbox"/> Anti-puncture - Colour Grey	(22")		04181 105,00
<input type="checkbox"/> Anti-puncture - Colour Black	(24")		11083 95,00
Not available with Rear wheels : 24" ULTRA-LIGHT PROGEO KEY SPORT, 24" Ultra-light "Spinergy LXL"			

Handrim	Wheel distance ☆ 3 cm □ 4 cm			
☆ Aluminium	(22"-24"-25"-26")	<i>Lightest configuration</i>		
<input type="checkbox"/> Aluminium black SOFT-TOUCH	(24"-25")	(24" handrim, on 25" wheel is installed with spacers)	09170	160,00
<input type="checkbox"/> Chromed Steel	(24"-25")	(24" handrim, on 25" wheel is installed with spacers)	01684	160,00
<input type="checkbox"/> Titanium	(24"-25")	(24" handrim, on 25" wheel is installed with spacers)	13591	290,00
<input type="checkbox"/> Ultra Grepp	(24"-25")	(24" handrim, on 25" wheel is installed with spacers)	00017	290,00
<input type="checkbox"/> TOP FRICTION	(24"-25")	(24" handrim, on 25" wheel is installed with spacers)	11023	290,00
Oval countour with a rubber insert				
<input type="checkbox"/> NOVA H	(24"-25")	(24" handrim, on 25" wheel is installed with spacers)	11025	290,00
Ergonomic black profile				
<input type="checkbox"/> NOVA D	(24"-25")	(24" handrim, on 25" wheel is installed with spacers)	11026	290,00
Ergonomic profile with rubber coating (ideal for quadriplegics)				
<input type="checkbox"/> Silicon cover for standard aluminium handrim		Available for measures (22"- 24" - 26")	04050	172,00



Wheel locks			
☆ Bent lever push to lock			
<input type="checkbox"/> Straight lever push to lock			
<input type="checkbox"/> Straight lever pull to lock			
<input type="checkbox"/> Sport brake	<i>Lightest configuration</i>		06428 135,00
<input type="checkbox"/> Brake with extension lever push to lock			01949 68,00
<input type="checkbox"/> Brake with extension lever pull to lock			03372 68,00



Date	Order	User	Address
------------	-------------	------------	---------------

Mudguard			
☆ Carbon fibre mudguard			
<input type="checkbox"/> Carbon fibre Straight sideguard	☆ Aligned wheel	<input type="checkbox"/> Under wheel cm	<input type="checkbox"/> Above wheel cm
<input type="checkbox"/> Mudguard enlargement			
☆ + 0 cm			
<input type="checkbox"/> + 1 cm	<input type="checkbox"/> + 2 cm		12648
<input type="radio"/> Removable carbon fibre mudguard			04109 270,00
<input type="radio"/> Removable Carbon fibre straight sideguard	☆ Aligned wheel	<input type="checkbox"/> Under wheel cm	<input type="checkbox"/> Above wheel cm
<input type="radio"/> Welded straight mudguard	Available only with made-to-measure aluminium welded frame with fixed and welded back		08933 398,00
	☆ Aligned wheel	<input type="checkbox"/> Under wheel cm	<input type="checkbox"/> Above wheel cm

Armrests			
<input type="radio"/> Tubular armrests	(Swing away, removable and height adjustable armrest)		00694 270,00

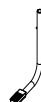
Accessories			
<input type="radio"/> Pad for front frame protectors			07058 56,00
<input type="radio"/> Backrest-seat connection cloth			10241 25,00
<input type="radio"/> Removable storage bag (with quick coupling)			09811 135,00

Optional 1			
<input type="checkbox"/> Set-up for post-sale optional assembly			
<input type="radio"/> Transit wheels			03290 158,00
<input type="radio"/> Crutches support	<input type="radio"/> Right <input type="radio"/> Left		00838 79,00 00837 79,00
<input type="radio"/> Anti-tipper with rapid hookup	(inside rotation to reduce the encumbrance) <input type="radio"/> Right <input type="radio"/> Left		06821 145,00 06822 145,00
<input type="radio"/> Tipping aid	<input type="radio"/> Right <input type="radio"/> Left		00025 79,00 01046 79,00

Optional 2			
<input type="radio"/> Push handles for companion	(Removable and height adjustable)		13600 189,00
<input type="radio"/> Tetraclip	(Quick release axle for quadriplegic)		03947 189,00
<input type="radio"/> Safety pelvic belt			03972 68,00
<input type="radio"/> Harness			04103 145,00
<input type="radio"/> Lumbar support	(to insert in the backrest upholstery)		00013 43,00
<input type="radio"/> Swing away lateral support Prevents backrest folding	Not available Harness PHYSIO - Harness A I R <input type="radio"/> Right <input type="radio"/> Left		02097 270,00 02098 270,00
<input type="radio"/> Spoke guards Black	(22"-24")		01043 158,00
<input type="radio"/> Spoke guards Transparent	(22"-24")		00835 158,00
<input type="radio"/> Spoke guards Progeo design	(22"-24")		00019 189,00

Additional Kit			
<input type="radio"/> 24" Off-road rear wheels	Off-Road tyre - aluminium handrim (black colour)		03378 534,00
<input type="radio"/> 24" FAT rear wheels	FAT tyre 3" - aluminium handrim (black colour)		09357 895,00







Permobil Limited Unit 7, Polaris Centre, 41 Brownfields, Welwyn Garden City, Herts, AL7 1AN United Kingdom - Phone: +44 1484 722888

Date Order User Address

PHYSIO - Posture backrest (Std. Backrest upholstery not provided)

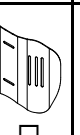

Removable with quick release
Suitable for tubes with diameter 18÷26mm
Depth adjustment (4cm)
Angle adjustment (±18°)

- AIR** Carbon shell
not available for seat width 48

BACKREST HEIGHT	28	34	40			
Shell's shape 	Lateral retaining wing A=high - R=regular					
	A	R	A	R	A	R
						
	<input type="checkbox"/>	<input type="checkbox"/>	<input type="checkbox"/>	<input type="checkbox"/>	<input type="checkbox"/>	<input type="checkbox"/>

1.121,00

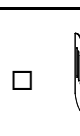
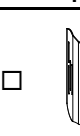
- POSTURE** Aluminum shell

BACKREST HEIGHT	34	40	52
Shell's shape 	Lateral retaining wing R=regular		
	R	R	R
			
	<input type="checkbox"/>	<input type="checkbox"/>	<input type="checkbox"/>

1.085,00

Configuration DEEP with side support PAD (height adjustable)

Alluminum lateral with padded, breathable upholstery.



Small (h 13cm)



- Right 10272
- Left 10272

49,00

Large (h 20cm)



- Right 10273
- Left 10273

49,00

SWING AWAY - Lateral support

Fixing and adjustment hardware complete with protection sleeve
Alluminum lateral with padded, breathable upholstery.

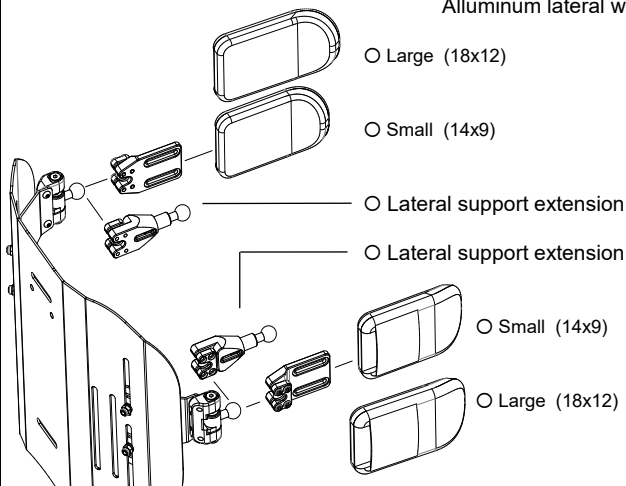

- Large (18x12)
- Small (14x9)

05647 196,00

05643 196,00

- Lateral support extension
- Lateral support extension

Quantity (number pcs)..... 10271 74,00

Quantity (number pcs).....

- Small (14x9)
- Large (18x12)

05642 196,00

05646 196,00

- Headrest adjustable - Double ball mounting system

Available only with backrest Physio Posture



- Large (35x12,5)
- Small (25x12,5)

05648 385,00

Date	Order	User	Address
------------	-------------	------------	---------------

1	A Footplate width			
	DP	35+39	40+45	46+50
LS				
33	21	20	19	
36	24	23	22	
39	26	25	24	
42	29	28	27	
45	32	31	30	
48	35	34	33	

2	Setting	C :
	Extremely prudential	7,5
	Prudential	9
	Standard	10,5
	Active	12
	Extreme	13,5

3	Lt
Camber	Maximum width
0°	LS + 18
2°	LS + 21
4°	LS + 24
8°	LS + 30
12°	LS + 36

Maximum width calculated including 3 cm. distance between tyre and handrim

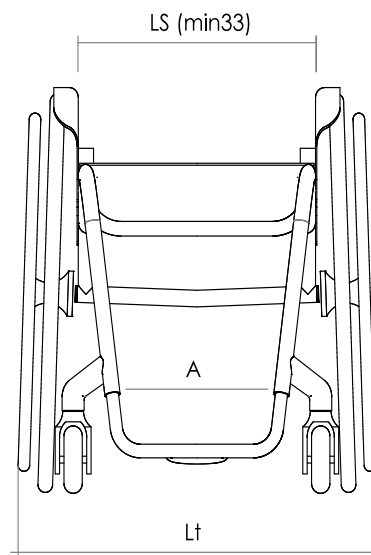
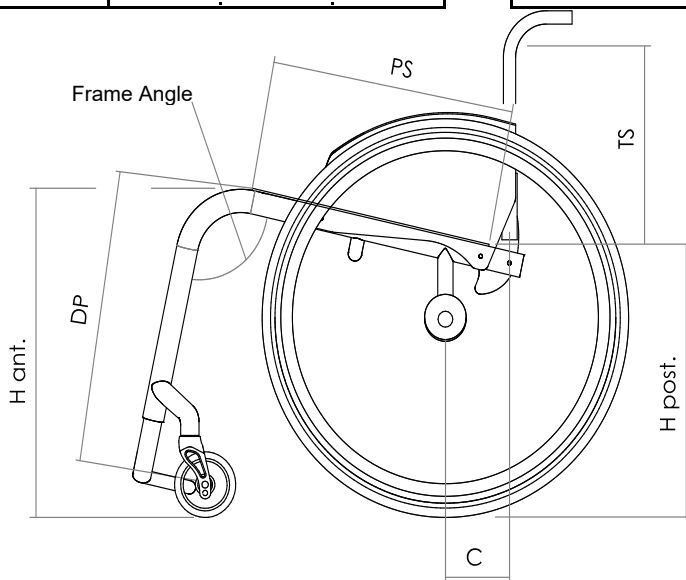



Wheelchair : Progeo JOKER ENERGY - Rev. 2026.0

Prices - VAT excluded
to be added to the price list

Send this page only if any optional have been chosen	
★ standard	(supplied if no requests are indicated)
□ on request	(without extra charge)
○ optional	(cost to be added at the basic price)

Date	Order	User	Address
------	-------	------	---------

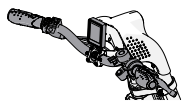
<p>12" wheel - Motor 250W (750W maximum power) 14" wheel - Motor 1000W (1500W maximum power)</p> <p>Color display with switcher Maximum speed limit settable from display 5 speed levels selectable 10 display-selectable acceleration levels Adaptive Cruise Control</p> <p>Disc and electronic brake control lever Motor brake (adjustable in 10 levels from the display) Electronic brake with control bottom (adjustable in 10 levels from the display) Power regain when braking</p> <p>Error messages management from display (with error history) Rear gear beeper 48V - 5.8 Ah battery Autonomy up to 25km 48V - 11.6 Ah Power plus battery Autonomy up to 50km Battery charger 48V</p> <p>Rear gear USB port Easle Mudguard Front spoiler with predisposition for FULL LED light</p> <p style="text-align: center;">(Certified software)</p>	
<p><input type="radio"/> Mototronik</p>	<p>10979 N/A</p>





<p>Handlebar</p>			
<p>☆ STANDARD controls</p> <p> ☆ Thumb accelerator</p> <p> <input type="radio"/> Grip throttle</p> <p> <input type="checkbox"/> Disc and electronic brake control lever</p>	<p> ☆ Right 12592</p> <p> <input type="radio"/> Right 10913</p> <p> ☆ Right 12594</p>	<p> <input type="checkbox"/> Left 12593</p> <p> <input type="radio"/> Left 10914</p> <p> <input type="checkbox"/> Left 12595</p>	 <p>42,00</p>  <p>428,00</p>
<p><input type="radio"/> QUADRIPLEGIC controls Handlebar PUSH&PULL</p>			

<p>☆ MOTOTRONIK 12" wheel Motor 250W (750W maximum power) Maximum speed according to law</p>	
<p><input type="radio"/> MOTOTRONIK 14" wheel Motor 1000W (1500W maximum power) Maximum speed according to law</p>	
	<p>10903 428,00</p>

<p>Battery</p>	
<p>☆ 48V - 5.8 Ah battery</p>	<p><i>Autonomy up to 25 km</i></p>
<p><input type="radio"/> 48V - 11.6 Ah Power plus battery</p>	<p><i>Autonomy up to 50 km</i></p> <p>10904 289,00</p>

Date Order User Address

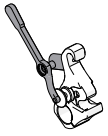
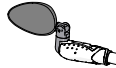
Accessories

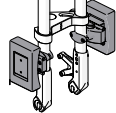
- | | | | | |
|---|---|---|--------|--------|
| <input type="radio"/> FULL LED light (high intensity)
Integrated in the spoiler |  | 10908 | 107,00 | |
| <input type="radio"/> Handlebar extension
Adjustable from 15cm up to 23cm |  | 10907 | 182,00 | |
| <input type="radio"/> Motor unit facilitated unlock lever
Recommended with handlebar for quadriplegic |  | 10915 | 82,00 | |
| <input type="radio"/> Additional FLY 48V - 2.9 Ah battery
Autonomy up to 15km
Approved for air transport | | 10906 | 697,00 | |
| <input type="radio"/> Rearview mirror | <input type="radio"/> Right
<input type="radio"/> Left |  | 10909 | 32,00 |
| <input type="radio"/> Basket (removable) - (with KLICKfix® attachment system) | |  | 10912 | 212,00 |
| <input type="radio"/> Removable front weight - (with KLICKfix® attachment system)
(it increases the weight over the power wheel to improve traction) | |  | 10910 | 311,00 |
| <input type="radio"/> Travel bag | | | 10916 | 155,00 |

Note

Send this page only if any optional have been chosen

- | | | |
|-------------------------------------|-------------------|---|
| <input checked="" type="checkbox"/> | standard | (supplied if no requests are indicated) |
| <input type="checkbox"/> | on request | (without extra charge) |
| <input type="radio"/> | optional | (cost to be added at the basic price) |