

Fitting / Order form

M3 Corpus

Prices valid from: 5/7/2021



M3 Corpus

Midwheel drive chair with Smooth suspension system.
 Standard equipped with airfilled tyres, 65 Ah maintenance free batteries, charger & 10 km/h top speed.
 The M3 Corpus is prepared to be equipped with bio mechanic powered backrest, elevating & articulating legrest, seat elevation and tilt. Ready to be accessorised with with the direct mount ROHO Agility back & Bodilink accessories.

| Dealer information | |
|------------------------|---|
| Customer (name / code) | / |
| Contact | |
| Address | |
| Post code / City | / |
| Phone / Fax | / |
| Client Information | |
| Name | / |
| Address | |
| Post code / City | / |
| Phone | |
| E-mail | |

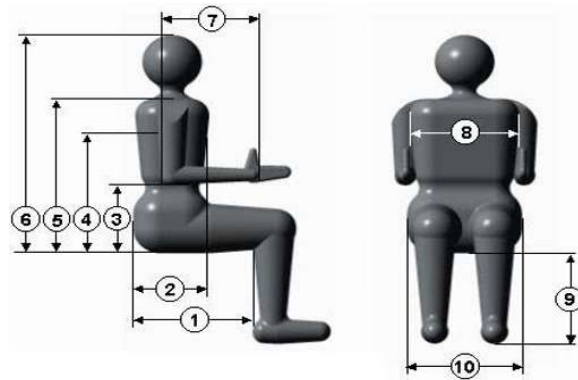







Anatomic Dimension

| | | | | | | | |
|-----------|--|----|----|----|----|-----|----|
| Diagnosis | Weight: kg | 3: | cm | 7: | cm | | |
| | Height: | cm | 4: | cm | 8: | cm | |
| | | 1: | cm | 5: | cm | 9: | cm |
| | | 2: | cm | 6: | cm | 10: | cm |

| Article code | Position Left Right | Price excl VAT | Price incl VAT | Funding code | Additional Info | <input checked="" type="checkbox"/> Required choice <input type="checkbox"/> / <input type="radio"/> Optional choice <input checked="" type="checkbox"/> / <input checked="" type="radio"/> Default required option |
|--------------|---------------------|----------------|----------------|--------------|-----------------|---|
|--------------|---------------------|----------------|----------------|--------------|-----------------|---|

| Chassis | | | | | | |
|-----------------|-------------|-------------------------------------|---------|--|--|--|
| M3 CORPUS | 109052-99-0 | <input checked="" type="checkbox"/> | 6225.00 | | | |
| ESP | | | | | | |
| ESP | 107998-99-0 | <input type="checkbox"/> | 897.00 | | | |
| Connect-Me | | | | | | |
| CONNECTME 4G EU | 108853-99-0 | <input checked="" type="checkbox"/> | 0.00 | | | |
| Sports Driving | | | | | | |
| SPORTS DRIVING | 108183-99-0 | <input type="checkbox"/> | 0.00 | | | |

| Accent colour | | | | | |
|--|-------------|----------------------------------|-----------------------|--------|--|
| Chassis / Wheels (no charge) | | | | | |
| COVER ACCENT COLOUR AQUA | 109083-99-0 | <input type="radio"/> | <input type="radio"/> | 0.00 | |
| COVER ACCENT COLOUR SKY | 109084-99-0 | <input type="radio"/> | <input type="radio"/> | 0.00 | |
| COVER ACCENT COLOUR VIOLET | 109085-99-0 | <input type="radio"/> | <input type="radio"/> | 0.00 | |
| COVER ACCENT COLOUR FLAMINGO | 109086-99-0 | <input type="radio"/> | <input type="radio"/> | 0.00 | |
| COVER ACCENT COLOUR CHILI | 109087-99-0 | <input type="radio"/> | <input type="radio"/> | 0.00 | |
| COVER ACCENT COLOUR CANARY | 109088-99-0 | <input type="radio"/> | <input type="radio"/> | 0.00 | |
| COVER ACCENT COLOUR SPRING | 109089-99-0 | <input type="radio"/> | <input type="radio"/> | 0.00 | |
| COVER ACCENT COLOUR ARCTIC | 109090-99-0 | <input type="radio"/> | <input type="radio"/> | 0.00 | |
| COVER ACCENT COLOUR SUNSET | 109091-99-0 | <input type="radio"/> | <input type="radio"/> | 0.00 | |
| COVER ACCENT COLOUR MIDNIGHT BLACK | 109176-99-0 | <input type="radio"/> | <input type="radio"/> | 0.00 | |
| COVER ACCENT COLOUR GOLD | 109092-99-0 | <input type="radio"/> | <input type="radio"/> | 127.00 | |
| COVER ACCENT COLOUR BRONZE | 109093-99-0 | <input type="radio"/> | <input type="radio"/> | 127.00 | |
| COVER ACCENT COLOUR PLATINUM | 109094-99-0 | <input type="radio"/> | <input type="radio"/> | 127.00 | |
| Drive wheels | | | | | |
| WHEELS 3.00x8" AIR FILLED TIRES BLACK | 108411-99-0 | <input checked="" type="radio"/> | | 0.00 | |
| WHEELS 3.00x8" SOLID TIRES BLACK | 108414-99-0 | <input type="radio"/> | | 211.00 |  107289-99-0 |
| WHEELS 3.00x8" AIR FILLED TIRES/SNOW AND MUD BLACK | 108412-99-0 | <input type="radio"/> | | 74.00 |  107854-99-0 107855-99-0 |
| Batteries | | | | | |
| BATTERIES, 65Ah, SET OF 2 PERMOBIL | 109183-99-0 | <input checked="" type="radio"/> | | 0.00 | |
| BATTERIES, 85Ah, SET OF 2 PERMOBIL UPCHARGE | 109307-99-0 | <input type="radio"/> | | 132.00 | |
| Charger | | | | | |
| CHARGER VOLTPRO 24/10 PERMOBIL GEL-AGM IP44 GB | 109166-99-0 | <input checked="" type="radio"/> | | 0.00 | |
| Light kit | | | | | |
| REFLECTOR KIT | 108415-99-0 | <input checked="" type="radio"/> | | 0.00 | |
| LIGHT KIT M-SERIES | 109168-99-0 | <input type="radio"/> | | 403.00 | |
| Accessories chassis | | | | | |
| LUGGAGE CARRIER WITH TAIL LIGHTS | 109169-99-0 | <input type="radio"/> | | 466.00 |  109170-99-0 |
| LUGGAGE CARRIER WITH REFLECTORS | 109170-99-0 | <input type="radio"/> | | 292.00 |  108526-99-0 |
| WITHOUT LUGGAGE CARRIER | 109284-99-0 | <input checked="" type="radio"/> | | 0.00 |  101888-99-0 101897-99-0 |
| PREPARED FOR DAHL CARLOCK | 108254-99-0 | <input type="radio"/> | | 146.00 | |
| MOUNTDAHL LOCKING PLATE | 109019-99-0 | <input type="radio"/> | | 485.00 |  109019-99-0 |
| REMOTE STOP | 108526-99-0 | <input type="checkbox"/> | | 491.00 |  108254-99-0 |
| TARPAULIN/RAINCOVER FOR ALL MODLES (NYLON) | 101888-99-0 | <input type="radio"/> | | 127.00 | |

| Seat assembly | | | | | | | | | | | |
|--|-------------|-------------------------------------|--------------------------|-------------------------------------|-------------------------------------|--------------------------|--------------------------|--------------------------|--------------------------|--------------------------|--|
| SEAT HEIGHT FIXED | 107097-99-0 | <input checked="" type="checkbox"/> | 0.00 | | | | | | | | |
| POWERED SEAT LIFT (REQ TILT) | 107098-99-0 | <input type="checkbox"/> | 739.00 | | | | | | | | |
| FIXED SEAT ANGEL | 107096-99-0 | <input checked="" type="checkbox"/> | 0.00 | | | | | | | | |
| POWERED ADJ. SEAT TILT 50° | 107095-99-0 | <input type="checkbox"/> | 1688.00 | | | | | | | | |
| WITHOUT ANTERIOR/NEGATIVE SEAT TILT | 107093-99-0 | <input checked="" type="checkbox"/> | 0.00 | | | | | | | | |
| 5° ACTIVE SEATING | 107099-99-0 | <input type="checkbox"/> | 0.00 | | | | | | | | |
| 10° ACTIVE SEATING | 107090-99-0 | <input type="checkbox"/> | 0.00 | | | | | | | | |
| 20° ACTIVE SEATING (REQ. LEGREST(X)+KNEESUPPORT) | 107091-99-0 | <input type="checkbox"/> | 0.00 | | | | | | | | |
| | | | | | | | | | | | |
| Seat sizes | | | | | | | | | | | |
| | | Depth | | | | | | | | | |
| Size (mm) | | 370 | 395 | 420 | 445 | 470 | 495 | 520 | 545 | 570 | |
| Width | 420 | <input type="checkbox"/> | <input type="checkbox"/> | <input type="checkbox"/> | <input type="checkbox"/> | <input type="checkbox"/> | <input type="checkbox"/> | <input type="checkbox"/> | <input type="checkbox"/> | <input type="checkbox"/> | |
| | 470 | <input type="checkbox"/> | <input type="checkbox"/> | <input checked="" type="checkbox"/> | <input type="checkbox"/> | <input type="checkbox"/> | <input type="checkbox"/> | <input type="checkbox"/> | <input type="checkbox"/> | <input type="checkbox"/> | |
| | 520 | <input type="checkbox"/> | <input type="checkbox"/> | <input type="checkbox"/> | <input type="checkbox"/> | <input type="checkbox"/> | <input type="checkbox"/> | <input type="checkbox"/> | <input type="checkbox"/> | <input type="checkbox"/> | |
| | 570 | <input type="checkbox"/> | <input type="checkbox"/> | <input type="checkbox"/> | <input type="checkbox"/> | <input type="checkbox"/> | <input type="checkbox"/> | <input type="checkbox"/> | <input type="checkbox"/> | <input type="checkbox"/> | |
| | | | | | | | | | | | |
| Seat cushion | | | | | | | | | | | |
| SEAT CUSHION VINYL | 10XXXX-99-0 | <input type="checkbox"/> | 0.00 | | | | | | | | |
| SEAT CUSHION STRETCH AIR | 10XXXX-99-0 | <input checked="" type="checkbox"/> | 0.00 | | | | | | | | |
| WITHOUT SEAT CUSHION | 105118-99-0 | <input type="checkbox"/> | -95.00 | | | | | | | | |
| ERGO SUPPORTS SEAT CUSHION | 105219-99-0 | <input checked="" type="checkbox"/> | 0.00 | | | | | | | | |
| Adjustment backrest | | | | | | | | | | | |
| POWERED ADJ. BACKREST 150° (LA28) | 107825-99-0 | <input type="checkbox"/> | 1002.00 | | | | | | | | |
| POWERED ADJ. BACKREST 180° (LA28) | 107755-99-0 | <input type="checkbox"/> | 1002.00 | | | | | | | | |
| MANUAL ADJUST. BACKREST | 108195-99-0 | <input checked="" type="checkbox"/> | 0.00 | | | | | | | | |
| BACKREST FIXED | 105066-99-0 | <input checked="" type="checkbox"/> | 0.00 | | | | | | | | |
| BACKREST BIO-MECH | 105067-99-0 | <input type="checkbox"/> | 633.00 | | | | | | | | |
| Backrest type | | | | | | | | | | | |
| SHORT | 107262-99-0 | <input type="checkbox"/> | 0.00 | | | | | | | | |
| STANDARD | 107264-99-0 | <input checked="" type="checkbox"/> | 0.00 | | | | | | | | |
| DIRECT BACKREST ADAPTER | 107261-99-0 | <input type="checkbox"/> | 410.00 | | | | | | | | |
| TUBELAR BACKREST ADAPTER | 107265-99-0 | <input type="checkbox"/> | 439.00 | | | | | | | | |
| WITHOUT BACKREST SHELL | 107272-99-0 | <input type="checkbox"/> | -125.00 | | | | | | | | |
| | | | | | | | | | | | |
| Backrest sizes | | | | | | | | | | | |
| | | Short | Standard heights | | | | | | | | |
| Size (mm) | | 470 | 545 | 570 | 595 | 620 | 645 | 670 | | | |
| Width | 360 | <input type="checkbox"/> | <input type="checkbox"/> | <input type="checkbox"/> | <input type="checkbox"/> | <input type="checkbox"/> | <input type="checkbox"/> | <input type="checkbox"/> | | | |
| | 410 | <input type="checkbox"/> | <input type="checkbox"/> | <input type="checkbox"/> | <input checked="" type="checkbox"/> | <input type="checkbox"/> | <input type="checkbox"/> | <input type="checkbox"/> | | | |
| | 460 | <input type="checkbox"/> | <input type="checkbox"/> | <input type="checkbox"/> | <input type="checkbox"/> | <input type="checkbox"/> | <input type="checkbox"/> | <input type="checkbox"/> | | | |
| | 510 | <input type="checkbox"/> | <input type="checkbox"/> | <input type="checkbox"/> | <input type="checkbox"/> | <input type="checkbox"/> | <input type="checkbox"/> | <input type="checkbox"/> | | | |
| | | | | | | | | | | | |

| Backrest cushion | | | | | | | | | | | |
|--|-------------|-----------------------|----------------------------------|-----------------------|------|-----------------------|-----------------------|-----------------------|-----------------------|--|--|
| BACKREST CUSHION VINYL | | 10XXXX-99-0 | <input type="radio"/> | 0.00 | | | | | | | |
| BACKREST CUSHION STRETCH AIR | | 10XXXX-99-0 | <input checked="" type="radio"/> | 0.00 | | | | | | | |
| WITHOUT BACKREST CUSHION | | 105117-99-0 | <input type="radio"/> | -95.00 | | | | | | | |
| ERGO SUPPORTS BACK SMALL (5 CM DEEP) | | 105569-99-0 | <input type="radio"/> | 253.00 | | | | | | | |
| ERGO SUPPORTS BACK LARGE (7 CM DEEP) | | 105570-99-0 | <input type="radio"/> | 253.00 | | | | | | | |
| Agility Max Contour | | | | | | | | | | | |
| | (H) | Height | | | (MH) | Mounting height | | | | | |
| (W) | Size ("/mm) | 16" | 18" | 20" | | 16" | 18" | 20" | 754.00 | | |
| Width | 14"/355mm | <input type="radio"/> | <input type="radio"/> | <input type="radio"/> | | <input type="radio"/> | | | | | |
| | 15"/380mm | <input type="radio"/> | <input type="radio"/> | <input type="radio"/> | | <input type="radio"/> | | | | | |
| | 16"/405mm | <input type="radio"/> | <input type="radio"/> | <input type="radio"/> | | <input type="radio"/> | <input type="radio"/> | | | | |
| | 17"/430mm | <input type="radio"/> | <input type="radio"/> | <input type="radio"/> | | <input type="radio"/> | <input type="radio"/> | <input type="radio"/> | | | |
| | 18"/455mm | <input type="radio"/> | <input type="radio"/> | <input type="radio"/> | | <input type="radio"/> | <input type="radio"/> | <input type="radio"/> | | | |
| | 19"/485mm | <input type="radio"/> | <input type="radio"/> | <input type="radio"/> | | <input type="radio"/> | <input type="radio"/> | <input type="radio"/> | | | |
| | 20"/510mm | <input type="radio"/> | <input type="radio"/> | <input type="radio"/> | | | <input type="radio"/> | <input type="radio"/> | | | |
| | | | | | | | | | <input type="radio"/> | | |
| | | | | | | | | | | | |
| | | | | | | | | | | | |
| Height Agility lateral supports | | | | | | | | | | | |
| AGILITY LATERAL SUPPORTS LOW POSITION (STANDARD) | | 108538-99-0 | <input checked="" type="radio"/> | 0.00 | | | | | | | |
| AGILITY LATERAL SUPPORTS HIGH POSITION | | 108537-99-0 | <input type="radio"/> | 0.00 | | | | | | | |
| Mounting armrests | | | | | | | | | | | |
| WIDTH BETWEEN ARMRESTS: NARROW (38-48CM) | | 107251-99-0 | <input checked="" type="radio"/> | 0.00 | | | | | | | |
| WIDTH BETWEEN ARMRESTS: WIDE (48-58CM) | | 107252-99-0 | <input type="radio"/> | 0.00 | | | | | | | |
| WIDTH BETWEEN ARMRESTS SET TO 380MM | | 105083-99-0 | <input type="radio"/> | 0.00 | | | | | | | |
| WIDTH BETWEEN ARMRESTS SET TO 430MM | | 105084-99-0 | <input checked="" type="radio"/> | 0.00 | | | | | | | |
| WIDTH BETWEEN ARMRESTS SET TO 480MM | | 105085-99-0 | <input type="radio"/> | 0.00 | | | | | | | |
| WIDTH BETWEEN ARMRESTS SET TO 530MM | | 105086-99-0 | <input type="radio"/> | 0.00 | | | | | | | |
| WIDTH BETWEEN ARMRESTS SET TO 580MM | | 105082-99-0 | <input type="radio"/> | 0.00 | | | | | | | |
| ARMREST HEIGHT POS 1: 230MM (FROM SEAT PAN) | | 106631-99-0 | <input type="radio"/> | 0.00 | | | | | | | |
| ARMREST HEIGHT POS 2: 255MM (FROM SEAT PAN) | | 106632-99-0 | <input type="radio"/> | 0.00 | | | | | | | |
| ARMREST HEIGHT POS 3: 280MM (FROM SEAT PAN) | | 106633-99-0 | <input checked="" type="radio"/> | 0.00 | | | | | | | |
| ARMREST HEIGHT POS 4: 305MM (FROM SEAT PAN) | | 106634-99-0 | <input type="radio"/> | 0.00 | | | | | | | |
| ARMREST HEIGHT POS 5: 330MM (FROM SEAT PAN) | | 106635-99-0 | <input type="radio"/> | 0.00 | | | | | | | |
| ARMREST HOLDERS FIXED | | 105070-99-0 | <input checked="" type="radio"/> | 0.00 | | | | | | | |
| ARMREST HOLDERS SWIVEL | | 105072-99-0 | <input type="radio"/> | 158.00 | | | | | | | |

| Armrests | | | | | | | | | | | |
|---|-----------------------|----------------------------------|-----------------------|-----------------------|-----------------------|----------------------------------|-----------------------|-----------------------|--|--|---------|
| | Left | | | | Right | | | | | | |
| | 260 | 335 | 410 | 460 | 260 | 335 | 410 | 460 | | | |
| WITHOUT ARMREST | <input type="radio"/> | <input type="radio"/> | <input type="radio"/> | <input type="radio"/> | <input type="radio"/> | <input type="radio"/> | <input type="radio"/> | <input type="radio"/> | | | |
| TEXTILE ARMREST | <input type="radio"/> | <input type="radio"/> | <input type="radio"/> | <input type="radio"/> | <input type="radio"/> | <input type="radio"/> | <input type="radio"/> | <input type="radio"/> | | | -42.00 |
| VINYL ARMREST | <input type="radio"/> | <input checked="" type="radio"/> | <input type="radio"/> | <input type="radio"/> | <input type="radio"/> | <input checked="" type="radio"/> | <input type="radio"/> | <input type="radio"/> | | | 0.00 |
| GEL ARMREST | <input type="radio"/> | <input type="radio"/> | <input type="radio"/> | <input type="radio"/> | <input type="radio"/> | <input type="radio"/> | <input type="radio"/> | <input type="radio"/> | | | 129.00 |
| MOLDED ARMREST LEFT | | | | | 108860-99-0 | <input type="radio"/> | | | | | 206.00 |
| MOLDED ARMREST RIGHT | | | | | 108861-99-0 | | | <input type="radio"/> | | | 206.00 |
| MOLDED HAND PAD MEDIUM LEFT | | | | | 108862-99-0 | <input type="radio"/> | | | | | 84.00 |
| MOLDED HAND PAD MEDIUM RIGHT | | | | | 108863-99-0 | | | <input type="radio"/> | | | 84.00 |
| MOLDED HAND PAD LARGE LEFT | | | | | 108864-99-0 | <input type="radio"/> | | | | | 95.00 |
| MOLDED HAND PAD LARGE RIGHT | | | | | 108865-99-0 | | | <input type="radio"/> | | | 95.00 |
| Adjustment legrest | | | | | | | | | | | |
| POWERED ADJ. LEGREST CORPUS (LA28) | | | | | 107757-99-0 | <input type="radio"/> | | | | | 1161.00 |
| POWERED ADJ. LEGREST CORPUS POW EXT LEG (LA28) | | | | | 107758-99-0 | <input type="radio"/> | | | | | 1161.00 |
| MANUAL ADJUSTMENT LEGREST (BRACKET LA28) | | | | | 107763-99-0 | <input checked="" type="radio"/> | | | | | 0.00 |
| Legrest | | | | | | | | | | | |
| LEGREST W. 205MM LENGTH COMPENSATION | | | | | 107012-99-0 | <input checked="" type="radio"/> | | | | | 0.00 |
| LEGREST W. 185MM LENGTH COMPENSATION | | | | | 107184-99-0 | <input type="radio"/> | | | | | 0.00 |
| LEGREST WITH POW. LENGTH COMPENSATION 20CM (X) | | | | | 107185-99-0 | <input type="radio"/> | | | | | 1002.00 |
| LEGREST W. 32-41(+10)CM HEIGHT ADJ. FOOTPL. | | | | | 107219-99-0 | <input type="radio"/> | | | | | 1741.00 |
| LEGREST W. 35-44(+10)CM HEIGHT ADJ. FOOTPL. | | | | | 107220-99-0 | <input type="radio"/> | | | | | 1741.00 |
| WITHOUT LEGREST | | | | | 105760-99-0 | <input type="radio"/> | | | | | 0.00 |
| Footplates | | | | | | | | | | | |
| DUAL FOOTPLATE 16CM LEG LENGTH 29-50CM AL. | | | | | 105436-99-0 | <input checked="" type="radio"/> | | | | | 0.00 |
| DUAL FOOTPLATE 20CM LEG LENGTH 29-50CM | | | | | 105437-99-0 | <input type="radio"/> | | | | | 0.00 |
| FOOTPLATE 1 PIECE LEG LENGTH 29-50CM | | | | | 106760-99-0 | <input type="radio"/> | | | | | 0.00 |
| DUAL FOOTPLATE 16CM LEG LENGTH 14-30CM AL. | | | | | 105438-99-0 | <input type="radio"/> | | | | | 0.00 |
| DUAL FOOTPLATE 20CM LEG LENGTH 14-30CM | | | | | 105439-99-0 | <input type="radio"/> | | | | | 0.00 |
| DUAL FOOTPLATE 16CM LEG LENGTH 25-50CM (PWR) | | | | | 106967-99-0 | <input type="radio"/> | | | | | 0.00 |
| FOOTPLATE 1P. 42CM LEG LENGTH 25-50CM (PWR FOOT) | | | | | 106969-99-0 | <input type="radio"/> | | | | | 0.00 |
| DUAL FOOTPLATE 20CM LEG LENGTH 25-50CM (PWR FOOT) | | | | | 106971-99-0 | <input type="radio"/> | | | | | 0.00 |
| DUAL FOOTPLATE 16CM LEG LENGTH <25CM (PWR) | | | | | 106966-99-0 | <input type="radio"/> | | | | | 0.00 |
| DUAL FOOTPLATE 20CM LEG LENGTH <25CM (PWR FOOT) | | | | | 106970-99-0 | <input type="radio"/> | | | | | 0.00 |
| FOOTPLATE 1P. 42CM LEG LENGTH <25CM (PWR FOOT) | | | | | 106968-99-0 | <input type="radio"/> | | | | | 0.00 |
| DUAL FOOTPLATE 16CM | | | | | 107453-99-0 | <input type="radio"/> | | | | | 0.00 |
| DUAL FOOTPLATE 20CM | | | | | 106008-99-0 | <input type="radio"/> | | | | | 0.00 |
| FOOTPLATE CHOICE NOT REQUIRED | | | | | 106154-99-0 | <input type="radio"/> | | | | | 0.00 |

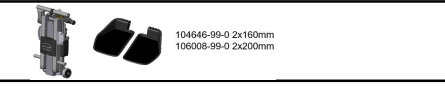
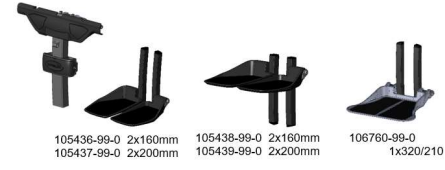
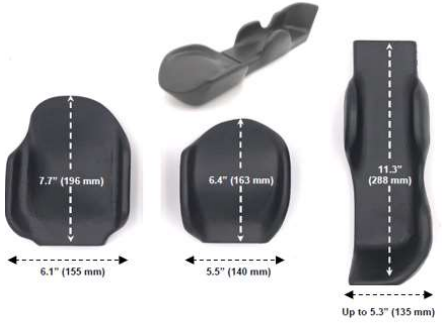
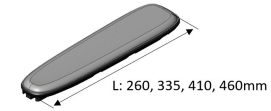

| Accessories seat | | | | | |
|--|-------------|---|--------|--|--|
| Headrest | | | | | |
| HEAD SUPPORT, ADJUSTABLE TEXTILE(BLACK) | 106336-99-0 | ○ | 206.00 | | |
| HEAD SUPPORT, ADJUSTABLE TEXTILE(BLACK)/SHORT BACK | 106337-99-0 | ○ | 206.00 | | |
| HEAD SUPPORT, ADJUSTABLE VINYL | 106331-99-0 | ○ | 206.00 | | |
| HEAD SUPPORT, ADJUSTABLE VINYL/SHORT BACK | 106338-99-0 | ○ | 193.00 | | |
| HEAD SUPPORT "ERGO" TEXTILE(BLACK) | 106333-99-0 | ○ | 206.00 | | |
| HEAD SUPPORT "ERGO" TEXT. (BLACK) SHORT BACK | 106335-99-0 | ○ | 206.00 | | |
| HEADREST ORIGINAL 340x130 LONG HOLDER, STD BACK | 107716-99-0 | ○ | 522.00 | | |
| HEADREST ORIGINAL 340x130 LONG HOLDER, SHORT BACK | 107715-99-0 | ○ | 522.00 | | |
| HEADREST ORIGINAL 340x130 STD HOLDER, STD BACK | 107718-99-0 | ○ | 469.00 | | |
| HEADREST ORIGINAL 340x130 STD HOLDER, SHORT BACK | 107717-99-0 | ○ | 469.00 | | |
| HEADREST ORIGINAL 250x125 LONG HOLDER, STD BACK | 107708-99-0 | ○ | 469.00 | | |
| HEADREST ORIGINAL 250x125 LONG HOLDER, SHORT BACK | 107719-99-0 | ○ | 469.00 | | |
| HEADREST ORIGINAL 250x125 STD HOLDER, STD BACK | 107710-99-0 | ○ | 417.00 | | |
| HEADREST ORIGINAL 250x125 STD HOLDER, SHORT BACK | 107709-99-0 | ○ | 417.00 | | |
| HEADREST ORIGINAL 180x110 LONG HOLDER, STD BACK | 107712-99-0 | ○ | 469.00 | | |
| HEADREST ORIGINAL 180x110 LONG HOLDER, SHORT BACK | 107711-99-0 | ○ | 469.00 | | |
| HEADREST ORIGINAL 180x110 STD HOLDER, STD BACK | 107714-99-0 | ○ | 417.00 | | |
| HEADREST ORIGINAL 180x110 STD HOLDER, SHORT BACK | 107713-99-0 | ○ | 417.00 | | |
| HEADREST ORIGINAL 180x110 STD HOLDER, AGILITY | 108579-99-0 | ○ | 417.00 | | |
| HEADREST ORIGINAL 180x110 LONG HOLDER, AGILITY | 108580-99-0 | ○ | 469.00 | | |
| HEADREST ORIGINAL 250x125 STD HOLDER, AGILITY | 108581-99-0 | ○ | 417.00 | | |
| HEADREST ORIGINAL 250x125 LONG HOLDER, AGILITY | 108582-99-0 | ○ | 469.00 | | |
| HEADREST ORIGINAL 340x130 STD HOLDER, AGILITY | 108583-99-0 | ○ | 469.00 | | |
| HEADREST ORIGINAL 340x130 LONG HOLDER, AGILITY | 108584-99-0 | ○ | 522.00 | | |
| BODILINK HEADREST L MAX 8 STD BACK | 108719-99-0 | ○ | 522.00 | | |
| BODILINK HEADREST L MAX 8 LOW BACK | 108720-99-0 | ○ | 522.00 | | |
| BODILINK HEADREST M MAX 8 STD BACK | 108717-99-0 | ○ | 469.00 | | |
| BODILINK HEADREST M MAX 8 LOW BACK | 108718-99-0 | ○ | 469.00 | | |
| BODILINK HEADREST S MAX 8 STD BACK | 109003-99-0 | ○ | 469.00 | | |
| BODILINK HEADREST S MAX 8 LOW BACK | 109004-99-0 | ○ | 469.00 | | |
| Facial support pad / switch Left | | | | | |
| SWING AWAY CHIN BOOM ASSY SUPPORT STD LEFT/HIGH | 107860-99-0 | ○ | 306.00 | | |
| SWING AWAY CHIN BOOM ASSY SUPPORT LONG LEFT/HIGH | 107861-99-0 | ○ | 306.00 | | |
| SWING AWAY CHIN BOOM ASSY F. HEADREST LEFT/HIGH | 107858-99-0 | ○ | 411.00 | | |
| SWING AWAY ASSY W. TASH MICRO LIGHT LEFT/HIGH | 107859-99-0 | ○ | 433.00 | | |
| Facial support pad / switch Right | | | | | |
| SWING AWAY ASSY W. FACIAL SUPPORT STD RIGHT/HIGH | 107941-99-0 | ○ | 306.00 | | |
| SWING AWAY ASSY W. FACIAL SUPPORT LONG RIGHT/HIGH | 107944-99-0 | ○ | 306.00 | | |
| SWING AWAY EGG SW. ASSY F. HEADREST RIGHT/HIGH | 107931-99-0 | ○ | 411.00 | | |
| SWING AWAY ASSY W. TASH MICRO LIGHT RIGHT/HIGH | 107935-99-0 | ○ | 433.00 | | |
| Extension cable | | | | | |
| EXTENSION CABLE 3MM STEREO, L=1M | 105931-99-0 | ○ | 45.00 | | |
| EXTENSION CABLE 3MM STEREO, L=2M | 105932-99-0 | ○ | 45.00 | | |



| Lateral support | | | | | |
|---|-------------|-----------------------|-----------------------|--------|--|
| BODILINK LATERAL SUPP. L. STRETCH-AIR 75X140 | 109025-99-0 | <input type="radio"/> | | 348.00 | |
| BODILINK LATERAL SUPP. L. STRETCH-AIR 100X165 | 109027-99-0 | <input type="radio"/> | | 348.00 | |
| BODILINK LATERAL SUPP. R. STRETCH-AIR 75X140 | 109026-99-0 | | <input type="radio"/> | 348.00 | |
| BODILINK LATERAL SUPP. R. STRETCH-AIR 100X165 | 109028-99-0 | | <input type="radio"/> | 348.00 | |
| LATERAL SUPPORT ORIGINAL LEFT 180X130 | 107720-99-0 | <input type="radio"/> | | 311.00 | |
| LATERAL SUPPORT ORIGINAL LEFT 130X80 | 107722-99-0 | <input type="radio"/> | | 311.00 | |
| LATERAL SUPPORT ORIGINAL RIGHT 180X130 | 107721-99-0 | | <input type="radio"/> | 311.00 | |
| LATERAL SUPPORT ORIGINAL RIGHT 130X80 | 107723-99-0 | | <input type="radio"/> | 311.00 | |
| Thigh supports | | | | | |
| BODILINK THIGH SUPPORT L. STRETCH-AIR 90X110 S(B) | 109179-99-0 | <input type="radio"/> | | 211.00 | |
| BODILINK THIGH SUPPORT L. STRETCH-AIR 200X90 L(C) | 109181-99-0 | <input type="radio"/> | | 232.00 | |
| BODILINK THIGH SUPPORT L. STRETCH-AIR 300x90 XL(G) | 109036-99-0 | <input type="radio"/> | | 253.00 | |
| BODILINK THIGH SUPPORT R. STRETCH-AIR 90X110 S(B) | 109180-99-0 | | <input type="radio"/> | 211.00 | |
| BODILINK THIGH SUPPORT R. STRETCH-AIR 200X90 L(C) | 109182-99-0 | | <input type="radio"/> | 232.00 | |
| BODILINK THIGH SUPPORT R. STRETCH-AIR 300x90 XL(G) | 109037-99-0 | | <input type="radio"/> | 253.00 | |
| THIGH SUPPORT LEFT TEXT. (MESH) 110x90 SMALL (B) | 107392-99-0 | <input type="radio"/> | | 158.00 | |
| THIGH SUPPORT LEFT TEXT. (MESH) 165x120 MEDIUM (J) | 107396-99-0 | <input type="radio"/> | | 179.00 | |
| THIGH SUPPORT LEFT TEXT. (MESH) 200x90 LARGE (C) | 107394-99-0 | <input type="radio"/> | | 179.00 | |
| THIGH SUPPORT LEFT TEXT. (MESH) 300x90 XLARGE (G) | 107390-99-0 | <input type="radio"/> | | 200.00 | |
| THIGH SUPPORT RIGHT TEXT. (MESH) 110x90 SMALL (B) | 107393-99-0 | | <input type="radio"/> | 158.00 | |
| THIGH SUPPORT RIGHT TEXT. (MESH) 165x120 MEDIUM (J) | 107397-99-0 | | <input type="radio"/> | 179.00 | |
| THIGH SUPPORT RIGHT TEXT. (MESH) 200x90 LARGE (C) | 107395-99-0 | | <input type="radio"/> | 179.00 | |
| THIGH SUPPORT RIGHT TEXT. (MESH) 300x90 XLARGE (G) | 107391-99-0 | | <input type="radio"/> | 200.00 | |
| Hip supports | | | | | |
| BODILINK HIP SUPPORT L. STRETCH-AIR 90X110 S(B) | 109032-99-0 | <input type="radio"/> | | 211.00 | |
| BODILINK HIP SUPPORT L. STRETCH-AIR 200X90 L(C) | 109034-99-0 | <input type="radio"/> | | 232.00 | |
| BODILINK HIP SUPPORT L. STRETCH-AIR 150X140 M(A) | 109038-99-0 | <input type="radio"/> | | 232.00 | |
| BODILINK HIP SUPPORT R. STRETCH-AIR 90X110 S(B) | 109033-99-0 | | <input type="radio"/> | 211.00 | |
| BODILINK HIP SUPPORT R. STRETCH-AIR 200X90 L(C) | 109035-99-0 | | <input type="radio"/> | 232.00 | |
| BODILINK HIP SUPPORT R. STRETCH-AIR 150X140 M(A) | 109039-99-0 | | <input type="radio"/> | 232.00 | |
| HIP SUPPORT LEFT TEXT. (MESH) 110x90 SMALL (B) | 107400-99-0 | <input type="radio"/> | | 158.00 | |
| HIP SUPPORT LEFT TEXT. (MESH) 150x140 MEDIUM (A) | 107398-99-0 | <input type="radio"/> | | 179.00 | |
| HIP SUPPORT LEFT TEXT. (MESH) 200x90 LARGE (C) | 107402-99-0 | <input type="radio"/> | | 179.00 | |
| HIP SUPPORT LEFT TEXT. (MESH) 200x200 XLARGE (D) | 107404-99-0 | <input type="radio"/> | | 222.00 | |
| HIP SUPPORT RIGHT TEXT. (MESH) 110x90 SMALL (B) | 107401-99-0 | | <input type="radio"/> | 158.00 | |
| HIP SUPPORT RIGHT TEXT. (MESH) 150x140 MEDIUM (A) | 107399-99-0 | | <input type="radio"/> | 179.00 | |
| HIP SUPPORT RIGHT TEXT. (MESH) 200x90 LARGE (C) | 107403-99-0 | | <input type="radio"/> | 179.00 | |
| HIP SUPPORT RIGHT TEXT. (MESH) 200x200 XLARGE (D) | 107405-99-0 | | <input type="radio"/> | 222.00 | |

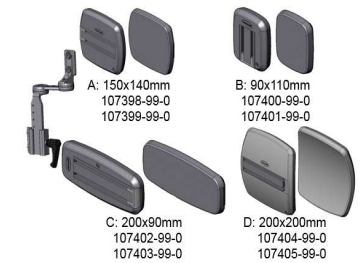
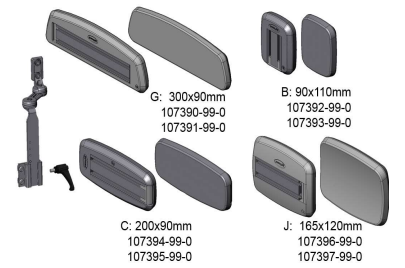
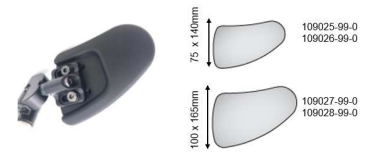

| Calf supports | | | | | |
|--|-------------|--------------------------|--------|--|--|
| CALF SUPPORTS S (B) 110x90 (MESH) | 105252-99-0 | <input type="radio"/> | 179.00 | | |
| CALF SUPPORTS M (J) 165x120 (MESH) | 105258-99-0 | <input type="radio"/> | 222.00 | | |
| CALF SUPPORTS L (A) 150x140 (MESH) | 105250-99-0 | <input type="radio"/> | 222.00 | | |
| CALF SUPPORTS XL (H) 170x175 (MESH) | 105256-99-0 | <input type="radio"/> | 306.00 | | |
| CALF SUPPORTS XXL (D) 200x200 (MESH) | 105254-99-0 | <input type="radio"/> | 306.00 | | |
| CALF SUPPORTS S (B) 110x90 (MESH) (VS/HD) | 107210-99-0 | <input type="radio"/> | 179.00 | | |
| CALF SUPPORTS M (J) 165x120 (MESH) (VS/HD) | 107211-99-0 | <input type="radio"/> | 222.00 | | |
| CALF SUPPORTS L (A) 150x140 (MESH) (VS/HD) | 106190-99-0 | <input type="radio"/> | 222.00 | | |
| CALF SUPPORTS XL (H) 170x175 (MESH) (VS/HD) | 106188-99-0 | <input type="radio"/> | 306.00 | | |
| CALF SUPPORTS XXL (D) 200x200 (MESH) (VS/HD) | 106186-99-0 | <input type="radio"/> | 306.00 | | |
| <p>A: 150x140mm 105250-99-0 106190-99-0</p> <p>D: 200x200mm 105254-99-0 106186-99-0</p> <p>J: 165x120mm 106617-99-0 105258-99-0 107211-99-0</p> <p>B: 90x110mm 105252-99-0 107210-99-0</p> <p>H: 170x175mm 105256-99-0 106188-99-0</p> | | | | | |
| Elbow and side supports armrests | | | | | |
| ELBOW SUPPORT LEFT | 107838-99-0 | <input type="checkbox"/> | 190.00 | | |
| ELBOW SUPPORT RIGHT | 107839-99-0 | <input type="checkbox"/> | 190.00 | | |
| ARMREST SIDE SUPPORT LEFT OUTSIDE | 107863-99-0 | <input type="checkbox"/> | 84.00 | | |
| ARMREST SIDE SUPPORT RIGHT OUTSIDE | 107840-99-0 | <input type="checkbox"/> | 84.00 | | |
| ARMREST SIDE SUPPORT LEFT INSIDE | 107865-99-0 | <input type="checkbox"/> | 84.00 | | |
| ARMREST SIDE SUPPORT RIGHT INSIDE | 107864-99-0 | <input type="checkbox"/> | 84.00 | | |
| <p>107840-99-0 107863-99-0 107864-99-0 107865-99-0</p> <p>107838-99-0 107839-99-0</p> | | | | | |
| Gel pads footplates | | | | | |
| STEALTH GEL PADS 16CM WIDE FOOTPATES | 106530-99-0 | <input type="checkbox"/> | 274.00 | | |
| STEALTH GEL PADS 20CM WIDE FOOTPATES | 106225-99-0 | <input type="checkbox"/> | 274.00 | | |
| Abduction wedge | | | | | |
| ABDUCTION WEDGE | 106762-99-0 | <input type="checkbox"/> | 320.00 | | |
| | | | | | |
| Shoulder support | | | | | |
| SHOULDER SUPPORT FOR 36CM WIDE BACKREST | 105410-99-0 | <input type="radio"/> | 85.00 | | |
| SHOULDER SUPPORT FOR 41CM WIDE BACKREST | 105411-99-0 | <input type="radio"/> | 85.00 | | |
| SHOULDER SUPPORT FOR 46CM WIDE BACKREST | 105412-99-0 | <input type="radio"/> | 85.00 | | |
| SHOULDER SUPPORT FOR 51CM WIDE BACKREST | 105854-99-0 | <input type="radio"/> | 85.00 | | |
| <p>36cm: 105410-99-0 41cm: 105411-99-0 46cm: 105412-99-0 51cm: 105854-99-0</p> | | | | | |
| Stump supports | | | | | |
| STUMP SUPPORT SMALL (A) 150x140 TEXTILE (MESH) | 106497-99-0 | <input type="radio"/> | 222.00 | | |
| STUMP SUPPORT MEDIUM (J) 165x120 TEXTILE (MESH) | 106500-99-0 | <input type="radio"/> | 222.00 | | |
| STUMP SUPPORT LARGE (H) 170x175 TEXTILE (MESH) | 106499-99-0 | <input type="radio"/> | 306.00 | | |
| STUMP SUPPORT XLARGE (D) 200x200 TEXTILE (MESH) | 106498-99-0 | <input type="radio"/> | 306.00 | | |
| <p>A: 150x140mm 103067-99-0</p> <p>J: 165x120mm 103068-99-0</p> <p>D: 200x200mm 103071-99-0</p> <p>H: 170x175mm 103070-99-0</p> | | | | | |
| Knee support | | | | | |
| KNEE SUPPORT WITH TEXTIEL UPHOLSTERY | 107285-99-0 | <input type="checkbox"/> | 369.00 | | |
| HOLDER KNEE SUPPORT UNITRACK | 107028-99-0 | <input type="checkbox"/> | 39.00 | | |
| <p>107285-99-0</p> <p>107028-99-0</p> | | | | | |
| Lumbar support | | | | | |
| LUMBAR SUPPORT,AIR | 101972-99-0 | <input type="checkbox"/> | 148.00 | | |
| | | | | | |

| Seatbelts | | | | | | |
|--|-------------|-----------------------|-----------------------|--------|--|--|
| CHEST STRAP BODYPOINT ELASTIC LARGE | 105843-99-0 | <input type="radio"/> | | 69.00 | | |
| CHEST STRAP BODYPOINT ELASTIC SMALL | 105845-99-0 | <input type="radio"/> | | 69.00 | | |
| SEATBELT, BODYPOINT 2- POINT, MEDIUM, NON-PADDED | 104518-99-0 | <input type="radio"/> | | 63.00 | | |
| SEATBELT, BODYPOINT 2- POINT, LARGE, NON-PADDED | 104514-99-0 | <input type="radio"/> | | 63.00 | | |
| SEATBELT, BODYPOINT 2- POINT, MEDIUM, PADDED | 104520-99-0 | <input type="radio"/> | | 90.00 | | |
| SEATBELT, BODYPOINT 2- POINT, LARGE, PADDED | 104516-99-0 | <input type="radio"/> | | 90.00 | | |
| BP HIP BELT, 2P C PULL LATCH 46CM PAD | 108267-99-0 | <input type="radio"/> | | 90.00 | | |
| BP HIP BELT, 2P C PULL LATCH 62CM PAD | 108266-99-0 | <input type="radio"/> | | 90.00 | | |
| BP HIP BELT, 4P R PULL PUSHBUTT. 46CM PAD | 108265-99-0 | <input type="radio"/> | | 121.00 | | |
| SAFETY BELT, BUCKLE | 100518-99-0 | <input type="radio"/> | | 53.00 | | |
| SAFETY BELT, AUTOTENSION | 100519-99-0 | <input type="radio"/> | <input type="radio"/> | 100.00 | | |
| SAFETY BELT, AUTOTENSION LONG VERSION | 100600-99-0 | <input type="radio"/> | <input type="radio"/> | 100.00 | | |
| SAFETY BELT, 4-POINT | 100529-99-0 | <input type="radio"/> | | 127.00 | | |
| SEATBELT, BODYPOINT MONOFLEX MEDIUM | 105840-99-0 | <input type="radio"/> | | 76.00 | | |
| SEATBELT, BODYPOINT MONOFLEX LARGE | 105839-99-0 | <input type="radio"/> | | 76.00 | | |
| SEATBELT, BODYPOINT MONOFLEX X-LARGE | 105850-99-0 | <input type="radio"/> | | 76.00 | | |
| BP HARNESS PIVOTFIT S SHOULDER SUPPORT FP | 108275-99-0 | <input type="radio"/> | | 115.00 | | |
| BP HARNESS PIVOTFIT M SHOULDER SUPPORT FP | 108276-99-0 | <input type="radio"/> | | 115.00 | | |
| BP HARNESS PIVOTFIT L SHOULDER SUPPORT FP | 108277-99-0 | <input type="radio"/> | | 115.00 | | |
| BP HARNESS PIVOTFIT XL SHOULDER SUPPORT FP | 108278-99-0 | <input type="radio"/> | | 115.00 | | |
| BP HARNESS STAYFLEX XS CHEST SUPPORT FP | 108269-99-0 | <input type="radio"/> | | 136.00 | | |
| BP HARNESS STAYFLEX S CHEST SUPPORT FP | 108270-99-0 | <input type="radio"/> | | 136.00 | | |
| BP HARNESS STAYFLEX M CHEST SUPPORT FP | 108271-99-0 | <input type="radio"/> | | 136.00 | | |
| BP HARNESS STAYFLEX L CHEST SUPPORT FP | 108272-99-0 | <input type="radio"/> | | 136.00 | | |
| BP HARNESS STAYFLEX XL CHEST SUPPORT FP | 108273-99-0 | <input type="radio"/> | | 136.00 | | |
| FOOTSTRAPS WITH PADS (SET OF 2) | 103104-99-0 | <input type="radio"/> | | 84.00 | | |
| FOOTSTRAPS WITHOUT PADS (SET OF 2) | 103427-99-0 | <input type="radio"/> | | 37.00 | | |
| BP ANKEL HUGGERS MEDIUM | 108242-99-0 | <input type="radio"/> | | 127.00 | | |
| BP ANKEL HUGGERS LARGE | 108243-99-0 | <input type="radio"/> | | 127.00 | | |
| Alternative seat cushions / options | | | | | | |
| INCONTINENCE PROTECTIVE COVER | 0 | <input type="radio"/> | | 146.00 | | |
| SEAT CUSHION ERGO AIR | | <input type="radio"/> | | 447.00 | | |
| ROHO QUADRO SELECT | | <input type="radio"/> | | 530.00 | | |
| ROHO CONTOUR | | <input type="radio"/> | | 530.00 | | |
| ROHO HYBRID ELITE | | <input type="radio"/> | | 440.00 | | |



| Tray tables | | | | | |
|--|-------------|--------------------------|--------------------------|--------|--|
| TABLE,SWING AWAY 600MM FOR JOYSTICK L/R | 105262-99-0 | <input type="radio"/> | <input type="radio"/> | 390.00 | |
| TABLE,SWING AWAY 650MM FOR JOYSTICK L/R | 105263-99-0 | <input type="radio"/> | <input type="radio"/> | 390.00 | |
| TABLE,SWING AWAY 600MM FOR JOYSTICK CENTER | 105264-99-0 | <input type="radio"/> | <input type="radio"/> | 390.00 | |
| TABLE,SWING AWAY 650MM FOR JOYSTICK CENTER | 105261-99-0 | <input type="radio"/> | <input type="radio"/> | 390.00 | |
| TABLE,REMOVABLE ANGLE ADJ LEFT, WIDTH 330MM | 108510-99-0 | <input type="radio"/> | | 390.00 | |
| TABLE,REMOVABLE ANGLE ADJ RIGHT, WIDTH 330MM | 108505-99-0 | | <input type="radio"/> | 390.00 | |
| TABLE,REMOVABLE ANGLE ADJ LEFT, WIDTH 381MM | 108511-99-0 | <input type="radio"/> | | 390.00 | |
| TABLE,REMOVABLE ANGLE ADJ RIGHT, WIDTH 381MM | 108506-99-0 | | <input type="radio"/> | 390.00 | |
| TABLE,REMOVABLE ANGLE ADJ LEFT, WIDTH 432MM | 108512-99-0 | <input type="radio"/> | | 390.00 | |
| TABLE,REMOVABLE ANGLE ADJ RIGHT, WIDTH 432MM | 108507-99-0 | | <input type="radio"/> | 390.00 | |
| TABLE,REMOVABLE ANGLE ADJ LEFT, WIDTH 482MM | 108513-99-0 | <input type="radio"/> | | 390.00 | |
| TABLE,REMOVABLE ANGLE ADJ RIGHT, WIDTH 482MM | 108508-99-0 | | <input type="radio"/> | 390.00 | |
| TABLE,ANGLE ADJUST. 1-SIDE FIXATION | 106863-99-0 | <input type="radio"/> | | 306.00 | |
| BRACKET ADDITIONAL POSITION TABLE | 107295-99-0 | | | 0.00 | |
| COLLEGE TABLE,LEFT | 105686-99-0 | <input type="radio"/> | | 206.00 | |
| COLLEGE TABLE RIGHT | 105831-99-0 | | <input type="radio"/> | 206.00 | |
| Pouches/Bags | | | | | |
| ARMREST POUCH,RIGHT BLACK | 107339-99-0 | | <input type="checkbox"/> | 34.00 | |
| ARMREST POUCH,LEFT BLACK | 107338-99-0 | <input type="checkbox"/> | | 34.00 | |
| SEATFRAME POUCH BLACK | 107340-99-0 | | <input type="checkbox"/> | 34.00 | |
| BACK PACK | 102059-99-0 | | <input type="checkbox"/> | 142.00 | |
| BACKPACK HOOKS,SET UNITRACK | 105563-99-0 | <input type="radio"/> | | 26.00 | |
| BACKPACK HOOK BACKREST PROFILE HIGH | 109186-99-0 | <input type="radio"/> | | 26.00 | |
| BACKPACK HOOK BACKREST PROFILE LOW | 109187-99-0 | <input type="radio"/> | | 26.00 | |
| POSITION LEFT BACKPACK HOOK ONLY | 109189-99-0 | <input type="radio"/> | | 0.00 | |
| POSITION RIGHT BACKPACK HOOK ONLY | 109188-99-0 | | <input type="radio"/> | 0.00 | |
| Other | | | | | |
| SUPPORT HANDLE ARMREST | 106058-99-0 | <input type="radio"/> | <input type="radio"/> | 101.00 | |
| TRANSFER HANDLES, SET | 105260-99-0 | | <input type="checkbox"/> | 158.00 | |
| PUSH HANDLES | 105292-99-0 | <input type="radio"/> | | 150.00 | |
| PUSH HANDLES (BACKREST 360) | 105795-99-0 | <input type="radio"/> | | 150.00 | |
| CRUTCH HOLDER | 105223-99-0 | <input type="radio"/> | <input type="radio"/> | 179.00 | |
| HOLDER OXYGEN BOTTLE C3G | 105224-99-0 | | <input type="checkbox"/> | 195.00 | |
| CUP HOLDER | 106210-99-0 | | <input type="checkbox"/> | 23.00 | |
| PHONE HOLDER X-GRIP | 106806-99-0 | | <input type="checkbox"/> | 66.00 | |
| TABLET HOLDER X-GRIP | 106972-99-0 | | <input type="checkbox"/> | 115.00 | |

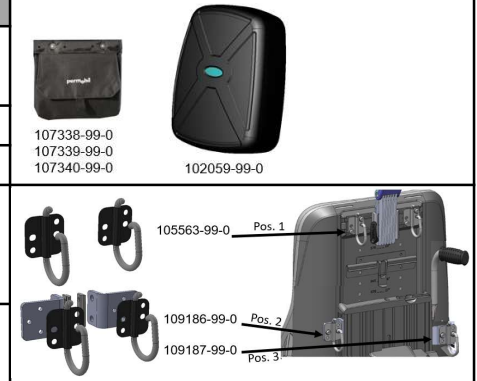
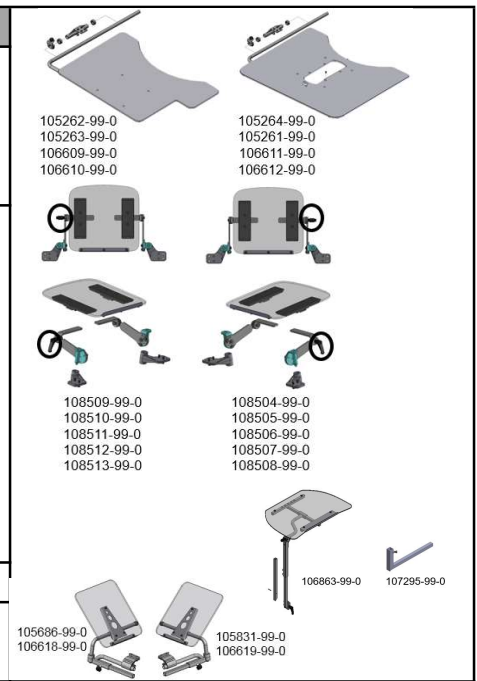



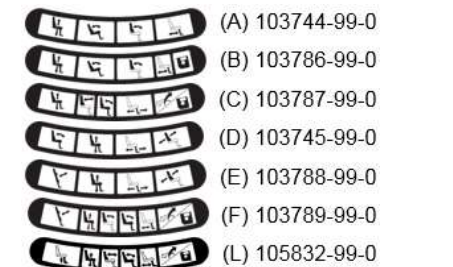





| Controls | | | | | |
|--|-------------|----------------------------------|----------------------------------|---------|--|
| User control | | | | | |
| JOYSTICK R-NET WITH 3.5" COLOR DISPLAY | 107159-99-0 | <input type="radio"/> | | 422.00 | |
| JOYSTICK R-NET WITH 3.5" COLOR DISPLAY WITH BT | 107779-99-0 | <input type="radio"/> | | 591.00 | |
| JOYSTICK R-NET "EL" LED | 105246-99-0 | <input checked="" type="radio"/> | | 0.00 | |
| JOYSTICK R-NET HEAVY DUTY WITH COLOUR DISPLAY | 105700-99-0 | <input type="radio"/> | | 791.00 | |
| MDT/RNET: JS COMPACT ADVANCED | 103814-99-0 | <input type="radio"/> | | 791.00 | |
| TABLE STEERING, FLIP-OVER 600MM, BACK W. 400/450 | 105293-99-0 | <input type="radio"/> | <input type="radio"/> | 1794.00 | |
| TABLE STEERING, FLIP-OVER 650MM, BACK W. 450 | 105294-99-0 | <input type="radio"/> | <input type="radio"/> | 1794.00 | |
| NON STANDARD STEERING (SEE SPECIAL CONTROLS) | 101352-99-0 | <input type="radio"/> | | 0.00 | |
| Parameters Joystick menu | | | | | |
| PROGR.SET: MEM RECALL VIA JS SEAT MENU OFF | 104907-99-0 | <input type="checkbox"/> | | 0.00 | |
| PROGR.SET: MEM SAVE VIA JS SEAT MENU OFF | 104927-99-0 | <input type="checkbox"/> | | 0.00 | |
| PROGR.SET: SEAT FUNCTIONS VIA JS SEAT MENU OFF | 104917-99-0 | <input type="checkbox"/> | | 0.00 | |
| Joystick holder | | | | | |
| PANELHOLDER PARALLEL MOTION UNITRACK | 107754-99-0 | <input type="radio"/> | <input type="radio"/> | 158.00 | |
| PANELHOLDER SWING AWAY L=335MM | 103473-99-0 | <input type="radio"/> | <input checked="" type="radio"/> | 0.00 | |
| PANELHOLDER SWING AWAY L=435MM | 103474-99-0 | <input type="radio"/> | <input type="radio"/> | 0.00 | |
| BODYPOINT MIDLINE MOUNT ASSEMBLY KIT R-NET | 108019-99-0 | <input type="radio"/> | <input type="radio"/> | 469.00 | |
| BODYPOINT MIDLINE MOUNT ASSEMBLY KIT CJS | 108020-99-0 | <input type="radio"/> | <input type="radio"/> | 469.00 | |
| PANEL HOLDER ATTENDANT LONG | 107788-99-0 | <input type="radio"/> | <input type="radio"/> | 162.00 | |
| WITHOUT PANELHOLDER | 102835-99-0 | <input type="radio"/> | | 0.00 | |
| Height adjustable holder | | | | | |
| HEIGHT ADJUSTABLE RIGHT JOYSTICK HOLDER | 107960-99-0 | <input type="radio"/> | | 116.00 | |
| HEIGHT ADJUSTABLE LEFT JOYSTICK HOLDER | 107963-99-0 | <input type="radio"/> | | 116.00 | |
| HEIGHT ADJUSTABLE JOYSTICK HOLDER | 108005-99-0 | <input type="radio"/> | | 116.00 | |
| Switch box | | | | | |
| SWITCH BOX WITH TOGGLE SWITCHES | 102799-99-0 | <input type="radio"/> | | 517.00 | |
| SWITCH BOX WITH PUSH BUTTONS | 102798-99-0 | <input type="radio"/> | | 517.00 | |
| WITHOUT SWITCH BOX | 104621-99-0 | <input checked="" type="radio"/> | | 0.00 | |
| Bracket switch box | | | | | |
| BRACKET SWITCH BOX JOYSTICK | 103469-99-0 | <input checked="" type="radio"/> | | 0.00 | |
| BRACKET SWITCH BOX UNITRACK ARMREST | 104651-99-0 | <input type="radio"/> | <input type="radio"/> | 37.00 | |
| BRACKET SWITCH BOX BACKREST | 106256-99-0 | <input type="radio"/> | <input type="radio"/> | 37.00 | |
| SWITCH BOX NOT MOUNTED | 105409-99-0 | <input type="radio"/> | | 0.00 | |
| Layout switch box | | | | | |
| SWITCHBOX(1) LAYOUT "A": SINGLE LAYER (STD) | 103744-99-0 | <input checked="" type="radio"/> | | 0.00 | |
| SWITCHBOX(1) LAYOUT "B": SINGLE LAYER, MEM | 103786-99-0 | <input type="radio"/> | | 0.00 | |
| SWITCHBOX(1) LAYOUT "C": SWAP LAYERS, MEM | 103787-99-0 | <input type="radio"/> | | 0.00 | |
| SWITCHBOX(1) LAYOUT "D": SINGLE LAYER (ALT SEQ) | 103745-99-0 | <input type="radio"/> | | 0.00 | |
| SWITCHBOX(1) LAYOUT "E": SINGLE LAYER, NO TILT | 103788-99-0 | <input type="radio"/> | | 0.00 | |
| SWITCHBOX(1) LAYOUT "F": SINGLE STAND, SWAP, MEM | 103789-99-0 | <input type="radio"/> | | 0.00 | |
| SWITCHBOX(1) LAYOUT "L": SWAP, MEM, 5 OPTIONS | 105832-99-0 | <input type="radio"/> | | 0.00 | |



| Indication level switch box | | | | |
|--|-------------|----------------------------------|-----------------------|---------|
| SWITCHBOX(1) IND. LEVEL 1: NONE | 103746-99-0 | <input type="radio"/> | | 0.00 |
| SWITCHBOX(1) IND. LEVEL 2: SEAT FUNCTION | 103747-99-0 | <input type="radio"/> | | 0.00 |
| SWITCHBOX(1) IND. LEVEL 3: SPEED LIMITATION | 103748-99-0 | <input type="radio"/> | | 0.00 |
| SWITCHBOX(1) IND. LEVEL 4: COMPLETE | 103749-99-0 | <input checked="" type="radio"/> | | 0.00 |
| External charging socket (required with table- or special control) | | | | |
| EXTRA CHARGER CONNECTOR MOUNTED ON THE ARMREST | 104163-99-0 | <input type="radio"/> | <input type="radio"/> | 100.00 |
| EXTRA CHARGER CONNECTOR MOUNTED ON ACC. RAIL | 104164-99-0 | <input type="radio"/> | <input type="radio"/> | 100.00 |
| EXTRA CHARGER CONNECTOR MOUNTED UNDER SEAT FRAME | 104165-99-0 | <input type="radio"/> | <input type="radio"/> | 100.00 |
| Lock Key | | | | |
| LOCKING KEY R-NET | 104620-99-0 | <input type="checkbox"/> | | 31.00 |
| Alternative Joystick knobs | | | | |
| JOYSTICK KNOB CHIN CUP | 100960-99-0 | <input type="radio"/> | | 31.00 |
| JOYSTICK KNOB T-GRIP | 100961-99-0 | <input type="radio"/> | | 31.00 |
| JOYSTICK KNOB BALL BIG | 100962-99-0 | <input type="radio"/> | | 31.00 |
| JOYSTICK KNOB SOFT BALL | 100963-99-0 | <input type="radio"/> | | 31.00 |
| JOYSTICK KNOB MUSHROOM | 100964-99-0 | <input type="radio"/> | | 31.00 |
| JOYSTICK KNOB STICK | 100965-99-0 | <input type="radio"/> | | 31.00 |
| JOYSTICK KNOB BALL SMALL | 101165-99-0 | <input type="radio"/> | | 31.00 |
| JOYSTICK KNOB STANDARD | 101166-99-0 | <input type="radio"/> | | 31.00 |
| JOYSTICK KNOB SOFT BALL BLACK (CONE) | 105442-99-0 | <input type="radio"/> | | 34.00 |
| JOYSTICK KNOB BODYPOINT 7.5CM U-SHAPED | 105846-99-0 | <input type="radio"/> | | 52.00 |
| JOYSTICK KNOB BODYPOINT 10CM U-SHAPED | 105847-99-0 | <input type="radio"/> | | 52.00 |
| JOYSTICK KNOB BODYPOINT RUBBER DOME | 105848-99-0 | <input type="radio"/> | | 47.00 |
| Attendant control | | | | |
| CO-PILOT | 105225-99-0 | <input type="radio"/> | | 1952.00 |
| JOYSTICK ATTENDANT RNET WITH 3.5" COLOR DISPLAY | 107318-99-0 | <input type="radio"/> | <input type="radio"/> | 865.00 |
| JOYSTICK ATTENDANT RNET SPEED/MODE | 107321-99-0 | <input type="radio"/> | <input type="radio"/> | 496.00 |
| Emergency switch | | | | |
| EMERGENCY STOP SWITCH | 101792-99-0 | <input type="checkbox"/> | | 174.00 |



| Supplementary accessoires | | | | | | | | |
|--|-------------|--------------------------|-----------------------|---------|--|---|---|---|
| (Mounting costs can apply) | | | | | | | | |
| MDT/RNET: JS COMPACT (LOW FORCE) | 103892-99-0 | <input type="radio"/> | | 1108.00 | |  |  |  |
| MDT/RNET: JS COMPACT | 103817-99-0 | <input type="radio"/> | | 686.00 | | | | |
| MDT/RNET: MINI JOYSTICK | 105289-99-0 | <input type="radio"/> | | 1899.00 | | | | |
| SWITCH KIT FOR COMPACT JS (CHIN) | 104641-99-0 | <input type="checkbox"/> | | 295.00 | | | | |
| PANEL HOLDER ATTENDANT | 105210-99-0 | <input type="checkbox"/> | | 148.00 | |  |  |  |
| CHEST SUPPORT FOR TABLE CII/VII VINYL | 101303-99-0 | <input type="checkbox"/> | | 158.00 | | | | |
| BLUETOOTH iDEVICE | 107350-99-0 | <input type="checkbox"/> | | 291.00 | | | | |
| ADAPT. CABLE BLUETOOTH MOUSE | 107359-99-0 | 0 | ▼ | 42.00 | | | | |
| CHARGER USB | 107189-99-0 | <input type="radio"/> | <input type="radio"/> | 121.00 | |  |  |  |
| BUDDY BUTTON BLACK 63 MM | 101766-99-0 | 0 | ▼ | 90.00 | | | | 101766-99-0 |
| BUDDY BUTTON RED 63 MM | 101767-99-0 | 0 | ▼ | 90.00 | | | | 101767-99-0 |
| BUDDY BUTTON YELLOW 63 MM | 101768-99-0 | 0 | ▼ | 90.00 | | | | 101768-99-0 |
| MICRO LIGHT SWITCH | 101769-99-0 | 0 | ▼ | 142.00 | | | | |
| CUP SWITCH 45 MM | 101770-99-0 | 0 | ▼ | 142.00 | | | | |
| MINI CUP SWITCH 24 MM | 101771-99-0 | 0 | ▼ | 121.00 | | | | |
| GRASP SWITCH | 101772-99-0 | 0 | ▼ | 206.00 | | | | |
| CONNECTION BOX EXTERNAL SWITCHES SEATING | 104196-99-0 | <input type="checkbox"/> | | 517.00 | | | | |
| CONNECTION BOX EXTERNAL SWITCHES R-NET (RBI) | 104696-99-0 | <input type="checkbox"/> | | 578.00 | | | | |



Notes